



**EurotestXE**  
**MI 3102H BT**  
**MI 3102 BT**  
**Instruction manual**  
*Version 1.5.3, Code no. 20 752 130*

**Distributor:**

**Manufacturer:**

METREL d.d.  
Ljubljanska cesta 77  
1354 Horjul  
Slovenia  
web site: <http://www.metrel.si>  
e-mail: [metrel@metrel.si](mailto:metrel@metrel.si)



Mark on your equipment certifies that it meets requirements of all subjected EU regulations

© 2021 METREL

*The trade names Metrel, Smartec, Eurotest, Autosequence are trademarks registered or pending in Europe and other countries.*

No part of this publication may be reproduced or utilized in any form or by any means without permission in writing from METREL.

# Table of Contents

<b>1</b>	<b>Preface.....</b>	<b>6</b>
<b>2</b>	<b>Safety and operational considerations .....</b>	<b>7</b>
2.1	Warnings and notes .....	7
2.2	Battery and charging .....	11
2.3	Standards applied .....	13
<b>3</b>	<b>Instrument description .....</b>	<b>14</b>
3.1	Front panel.....	14
3.2	Connector panel.....	15
3.3	Back side .....	16
3.4	Carrying the instrument .....	18
3.5	Instrument set and accessories.....	18
3.5.1	<i>Standard set MI 3102H BT – EurotestXE .....</i>	<i>18</i>
3.5.2	<i>Standard set MI 3102 BT – EurotestXE.....</i>	<i>19</i>
3.5.3	<i>Optional accessories .....</i>	<i>19</i>
<b>4</b>	<b>Instrument operation .....</b>	<b>20</b>
4.1	Display and sound.....	20
4.1.1	<i>Terminal voltage monitor .....</i>	<i>20</i>
4.1.2	<i>Battery indication.....</i>	<i>20</i>
4.1.3	<i>Messages.....</i>	<i>20</i>
4.1.4	<i>Results .....</i>	<i>21</i>
4.1.5	<i>Sound warnings.....</i>	<i>21</i>
4.1.6	<i>Help screens .....</i>	<i>22</i>
4.1.7	<i>Backlight and contrast adjustments .....</i>	<i>22</i>
4.2	Function selection .....	23
4.3	Instruments main menu .....	24
4.4	Settings.....	24
4.4.1	<i>Memory .....</i>	<i>25</i>
4.4.2	<i>Language .....</i>	<i>25</i>
4.4.3	<i>Date and time.....</i>	<i>25</i>
4.4.4	<i>Earthing system (MI 3102 BT only).....</i>	<i>26</i>
4.4.5	<i>RCD testing.....</i>	<i>26</i>
4.4.6	<i>Isc factor.....</i>	<i>28</i>
4.4.7	<i>Commander support.....</i>	<i>28</i>
4.4.8	<i>Initial settings .....</i>	<i>29</i>
4.4.9	<i>Clamp Settings.....</i>	<i>30</i>
4.4.10	<i>Length units.....</i>	<i>31</i>
<b>5</b>	<b>Measurements.....</b>	<b>32</b>
5.1	Voltage, frequency and phase sequence.....	32
5.2	Insulation resistance.....	34
5.3	The DAR and PI diagnostic (MI 3102H BT only).....	36
5.4	Resistance of earth connection and equipotential bonding.....	38
5.4.1	<i>R LOW<math>\Omega</math>, 200 mA resistance measurement .....</i>	<i>38</i>
5.4.2	<i>Continuous resistance measurement with low current.....</i>	<i>40</i>
5.4.3	<i>Compensation of test leads resistance .....</i>	<i>41</i>
5.5	Testing RCDs.....	42
5.5.1	<i>Contact voltage (RCD Uc) .....</i>	<i>43</i>
5.5.2	<i>Trip-out time (RCDt) .....</i>	<i>44</i>

5.5.3	Trip-out current (RCD I).....	45
5.5.4	RCD Auto-test.....	46
5.6	Fault loop impedance and prospective fault current.....	48
5.7	Line impedance and prospective short-circuit current / Voltage drop.....	50
5.7.1	Line impedance and prospective short circuit current.....	51
5.7.2	Voltage drop.....	52
5.8	Earth resistance.....	54
5.8.1	Standard earthing resistance measurement.....	55
5.8.2	Contactless earthing resistance measurement (with two current clamps).....	56
5.8.3	Specific earth resistance measurement.....	57
5.9	PE test terminal.....	58
5.10	Power.....	60
5.11	Harmonics.....	62
5.12	Current.....	63
5.13	First fault leakage current – ISFL (MI 3102 BT only).....	64
5.14	Testing of insulation monitoring devices – IMD (MI 3102 BT only).....	66
5.15	PE conductor resistance.....	69
5.16	Illumination.....	70
<b>6</b>	<b>Auto-sequences.....</b>	<b>72</b>
<b>7</b>	<b>Data handling.....</b>	<b>77</b>
7.1	Memory organization.....	77
7.2	Data structures.....	77
7.3	Storing test results.....	78
7.4	Recalling test results.....	79
7.5	Clearing stored data.....	80
7.5.1	Clearing complete memory content.....	80
7.5.2	Clearing measurement(s) in selected location.....	80
7.5.3	Clearing individual measurements.....	81
7.5.4	Renaming installation structure elements (upload from PC).....	81
7.5.5	Renaming installation structure elements with serial barcode reader or RFID reader.....	82
7.6	Communication.....	83
7.6.1	USB and RS232 communication.....	83
7.6.2	Bluetooth communication.....	84
<b>8</b>	<b>Upgrading the instrument.....</b>	<b>85</b>
<b>9</b>	<b>Maintenance.....</b>	<b>86</b>
9.1	Fuse replacement.....	86
9.2	Cleaning.....	86
9.3	Periodic calibration.....	86
9.4	Service.....	86
<b>10</b>	<b>Technical specifications.....</b>	<b>87</b>
10.1	Insulation resistance.....	87
10.2	Diagnostic test (MI 3102H BT only).....	88
10.3	Continuity.....	88
10.3.1	Resistance R LOW.....	88
10.3.2	Resistance CONTINUITY.....	88
10.4	RCD testing.....	89
10.4.1	General data.....	89
10.4.2	Contact voltage RCD $U_c$ .....	90
10.4.3	Trip-out time.....	90
10.4.4	Trip-out current.....	90

10.5	Fault loop impedance and prospective fault current.....	91
10.5.1	<i>No disconnecting device or FUSE selected</i> .....	91
10.5.2	<i>RCD selected</i> .....	91
10.6	Line impedance and prospective short-circuit current / Voltage drop.....	92
10.7	PE conductor resistance .....	93
10.7.1	<i>No RCD selected</i> .....	93
10.7.2	<i>RCD selected</i> .....	93
10.8	Resistance to earth .....	94
10.8.1	<i>Standard earthing resistance measurement – 3-wire measurement</i> .....	94
10.8.2	<i>Contactless earthing resistance measurement using two current clamps</i> .....	94
10.8.3	<i>Specific earth resistance measurements</i> .....	95
10.9	Voltage, frequency, and phase rotation .....	96
10.9.1	<i>Phase rotation</i> .....	96
10.9.2	<i>Voltage</i> .....	96
10.9.3	<i>Frequency</i> .....	96
10.9.4	<i>Online terminal voltage monitor</i> .....	96
10.10	TRMS Clamp current.....	97
10.11	Power tests .....	98
10.12	First fault leakage current – ISFL (MI 3102 BT only).....	99
10.13	Calibrated resistance for IMD testing (MI 3102 BT only).....	99
10.14	Illumination.....	100
10.14.1	<i>Illumination (Luxmeter sensor, type B)</i> .....	100
10.14.2	<i>Illumination (Luxmeter sensor, type C)</i> .....	100
10.15	General data .....	101
<b>Appendix A – Fuse table – IPSC.....</b>		<b>102</b>
<b>Appendix B – Accessories for specific measurements.....</b>		<b>106</b>
<b>Appendix C – Country notes.....</b>		<b>108</b>
C.1	List of country modifications .....	108
C.2	AT modification – G type RCD .....	108
C.3	Modification of the chapter 5.5.1.....	109
<b>Appendix D – Commanders (A 1314, A 1401).....</b>		<b>110</b>
D.1	 Warnings related to safety .....	110
D.2	Battery.....	110
D.3	Description of commanders.....	110
D.4	Operation of commanders .....	111

# 1 Preface

Congratulations on your purchase of the Eurotest instrument and its accessories from METREL. The instrument was designed on a basis of rich experience, acquired through many years of dealing with electric installation test equipment.

The Eurotest instrument is a professional, multifunctional, hand-held test instrument intended to perform all the measurements on a.c. electrical LV installations.

The following measurements and tests can be performed:

- Voltage and frequency,
- Continuity tests,
- Insulation resistance tests,
- Diagnostic tests (MI 3102H BT only),
- RCD testing,
- Fault loop / RCD trip-lock impedance measurements,
- Line impedance / Voltage drop,
- Phase sequence,
- Earth resistance tests,
- Current measurements,
- Power and harmonics measurements,
- Illumination,
- First fault current (MI 3102 BT only),
- Testing of insulation monitoring devices – IMD (MI 3102 BT only) and
- Pre-defined auto-sequences.

The graphic display with backlight offers easy reading of results, indications, measurement parameters and messages. Two LED PASS/FAIL indicators are placed at the sides of the LCD. The operation of the instrument is designed to be as simple and clear as possible and no special training (except for the reading this instruction manual) is required in order to begin using the instrument.

In order for operator to be familiar enough with performing measurements in general and their typical applications it is advisable to read METREL handbook ***Guide for testing and verification of low voltage installations***.

The instrument is equipped with the entire necessary accessory for comfortable testing.

## 2 Safety and operational considerations

### 2.1 Warnings and notes

In order to maintain the highest level of operator safety while carrying out various tests and measurements, METREL recommends keeping your Eurotest instruments in good condition and undamaged. When using the instrument, consider the following general warnings:



**General warnings related to safety:**

- ❑ The  symbol on the instrument means »Read the Instruction manual with special care for safe operation«. The symbol requires an action!
- ❑ If the test equipment is used in a manner not specified in this user manual, the protection provided by the equipment could be impaired!
- ❑ Read this user manual carefully, otherwise the use of the instrument may be dangerous for the operator, the instrument or for the equipment under test!
- ❑ Do not use the instrument or any of the accessories if any damage is noticed!
- ❑ Consider all generally known precautions in order to avoid risk of electric shock while dealing with hazardous voltages!
- ❑ In case a fuse has blown follow the instructions in this manual in order to replace it! Use only fuses that are specified!
- ❑ Do not use the instrument in AC supply systems with voltages higher than 550 Va.c.
- ❑ Service, repairs or adjustment of instruments and accessories is only allowed to be carried out by competent authorized personnel!
- ❑ Use only standard or optional test accessories supplied by your distributor!
- ❑ Consider that protection category of some accessories is lower than of the instrument. Test tips and Tip commander have removable caps. If they are removed the protection falls to CAT II. Check markings on accessories!  
cap off, 18 mm tip: CAT II up to 1000 V  
cap on, 4 mm tip: CAT II 1000 V / CAT III 600 V / CAT IV 300 V
- ❑ The instrument comes supplied with rechargeable Ni-MH battery cells. The cells should only be replaced with the same type as defined on the battery compartment label or as described in this manual. Do not use standard alkaline battery cells while the power supply adapter is connected, otherwise they may explode!
- ❑ Hazardous voltages exist inside the instrument. Disconnect all test leads, remove the power supply cable and switch off the instrument before removing battery compartment cover.
- ❑ Do not connect any voltage source on C1 input. It is intended only for connection of current clamps. Maximal input voltage is 3 V!

- ❑ All normal safety precautions must be taken in order to avoid risk of electric shock while working on electrical installations!



### Warnings related to safety of measurement functions:

#### Insulation resistance

- ❑ Insulation resistance measurement should only be performed on de-energized objects!
- ❑ Do not touch the test object during the measurement or before it is fully discharged! Risk of electric shock!
- ❑ When an insulation resistance measurement has been performed on a capacitive object, automatic discharge may not be done immediately! The warning message  and the actual voltage are displayed during discharge until voltage drops below 30 V.
- ❑ Do not connect test terminals to external voltage higher than 600 V (AC or DC) in order not to damage the test instrument!

#### Continuity functions

- ❑ Continuity measurements should only be performed on de-energized objects!
- ❑ Parallel loops may influence on test results.

#### Testing PE terminal

- ❑ If phase voltage is detected on the tested PE terminal, stop all measurements immediately and ensure the cause of the fault is eliminated before proceeding with any activity!

### Notes related to measurement functions:

#### General

- ❑ The  indicator means that the selected measurement cannot be performed because of irregular conditions on input terminals.
- ❑ Insulation resistance, continuity functions and earth resistance measurements can only be performed on de-energized objects.
- ❑ PASS / FAIL indication is enabled when limit is set. Apply appropriate limit value for evaluation of measurement results.
- ❑ In the case that only two of the three wires are connected to the electrical installation under test, only voltage indication between these two wires is valid.

#### Insulation resistance

- ❑ The standard three-wire test lead, schuko test cable or Plug / Tip commanders can be used for the insulation test with voltages  $\leq 1\text{kV}$ .
- ❑ The special two wire 2.5 kV test lead must be used for the insulation test with 2.5 kV. (MI 3102H BT only).
- ❑ If a voltage of higher than 30 V (AC or DC) is detected between test terminals, the insulation resistance measurement will not be performed.
- ❑ The instrument automatically discharge tested object after finished measurement.
- ❑ A double click of TEST key starts a continuous measurement.

#### Continuity functions



- ❑ If a voltage of higher than 10 V (AC or DC) is detected between test terminals, the continuity resistance test will not be performed.
- ❑ Compensate test lead resistance before performing a continuity measurement, where necessary.

### Earth resistance - RE, two clamps, specific earth resistance ( $\rho$ )

- ❑ If voltage between test terminals is higher than 30 V the resistance to earth measurement will not be performed.
- ❑ If a noise voltage higher than approx. 5 V is present between the H and E or S test terminals, “ $\lambda$ ” (noise) warning symbol will be displayed, indicating that the test result may not be correct!
- ❑ For two clamps earth resistance measurement clamps A 1018 and A 1019 should be used. Clamps A 1391 are not supported.
- ❑ For specific earth resistance measurements  $\rho$  Adaptor A 1199 should be used.

### RCD functions

- ❑ Parameters set in one function are also kept for other RCD functions!
- ❑ The measurement of contact voltage does not normally trip an RCD. However, the trip limit of the RCD may be exceeded as a result of leakage current flowing to the PE protective conductor or a capacitive connection between L and PE conductors.
- ❑ The RCD trip-lock sub-function (function selector in LOOP position) takes longer to complete but offers much better accuracy of fault loop resistance (in comparison to the  $R_L$  sub-result in Contact voltage function).
- ❑ RCD trip-out time and RCD trip-out current measurements will only be performed if the contact voltage in the pre-test at nominal differential current is lower than the set contact voltage limit!
- ❑ The auto-test sequence (RCD AUTO function) stops when trip-out time is out of allowable time period.

### Z-LOOP

- ❑ The low limit prospective short-circuit current value depends on fuse type, fuse current rating, fuse trip-out time and impedance scaling factor.
- ❑ The specified accuracy of tested parameters is valid only if the mains voltage is stable during the measurement.
- ❑ Fault loop impedance measurements will trip an RCD.
- ❑ The measurement of fault loop impedance using trip-lock function does not normally trip an RCD. However, the trip limit may be exceeded if a leakage current flows to the PE protective conductor or if there is a capacitive connection between L and PE conductors.

### Z-LINE / Voltage drop

- ❑ In case of measurement of  $Z_{\text{Line-Line}}$  with the instrument test leads PE and N connected together the instrument will display a warning of dangerous PE voltage. The measurement will be performed anyway.
- ❑ Specified accuracy of tested parameters is valid only if mains voltage is stable during the measurement.
- ❑ L and N test terminals are reversed automatically according to detected terminal voltage (except in UK version).

### Power / Harmonics / Current

- ❑ Before starting any power measurement, the current clamp settings in **Settings menu** should be checked. Select appropriate current clamp model and measuring range that are best fitted to the expected current values.
- ❑ Consider polarity of current clamp (arrow on test clamp should be oriented toward connected load), otherwise result will be negative!

### **Illumination**

- ❑ For accurate measurement make sure that the milk glass bulb is lit without any shadows cast by hand, body or other unwanted objects.
- ❑ It is very important to know that the artificial light sources reach full power of operation after a period of time (see technical data for light sources) and should be therefore switched on for this period of time before the measurements are taken.

### **Testing PE terminal**

- ❑ PE terminal can be tested in RCD, LOOP and LINE function selector positions only!
- ❑ For correct testing of PE terminal, the TEST key has to be touched for a few seconds.
- ❑ Make sure to stand on non-isolated floor while carrying out the test, otherwise test result may be wrong!

### **PE conductor resistance**

- ❑ The specified accuracy of tested parameters is valid only if the mains voltage is stable during the measurement.
- ❑ PE conductor resistance measurement will trip an RCD.
- ❑ The measurement of PE conductor resistance using trip-lock function does not normally trip an RCD. However, the trip limit may be exceeded if a leakage current flows to the PE protective conductor or if there is a capacitive connection between L and PE conductors.

### **Testing of Insulation monitoring devices (IMD) (MI 3102 BT only)**

- ❑ It is recommended to disconnect all appliances from the tested supply to receive regular test results. Any connected appliance will influence the insulation resistance threshold test.
- ❑ The displayed resistances and currents are indicative only. Displayed resistance can significantly differ from the actual resistance the Eurotest simulates. If IMD's with very low test currents (below 1mA) are checked the displayed resistance value is typically lower (and current higher) than the actual simulated resistance. The difference is lower for lower set resistances.

### **Auto-sequence tests**

See notes related to tests / measurements of selected auto-sequence.

## 2.2 Battery and charging

The instrument uses six AA size alkaline or rechargeable Ni-MH battery cells. Nominal operating time is declared for cells with nominal capacity of 2100 mAh. Battery condition is always displayed in the lower right display part. In case the battery is too weak the instrument indicates this as shown in figure 2.1. This indication appears for a few seconds and then the instrument turns itself off.

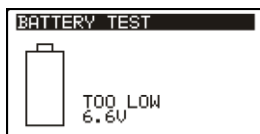

Figure 2.1: Discharged battery indication

The battery is charged whenever the power supply adapter is connected to the instrument. The power supply socket polarity is shown in figure 2.2. Internal circuit controls charging and assures maximum battery lifetime.



Figure 2.2: Power supply socket polarity

Symbols:

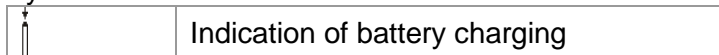

Figure 2.3: Charging indication



### Warnings related to safety:

- ❑ When connected to an installation, the instruments battery compartment can contain hazardous voltage inside! When replacing battery cells or before opening the battery/fuse compartment cover, disconnect any measuring accessory connected to the instrument and turn off the instrument,
- ❑ Ensure that the battery cells are inserted correctly otherwise the instrument will not operate and the batteries could be discharged.
- ❑ Do not recharge alkaline battery cells!
- ❑ Use only power supply adapter delivered from the manufacturer or distributor of the test equipment!

### Notes:

- ❑ The charger in the instrument is a pack cell charger. This means that the battery cells are connected in series during the charging. The battery cells have to be equivalent (same charge condition, same type and age).
- ❑ If the instrument is not to be used for a long period of time, remove all batteries from the battery compartment.
- ❑ Alkaline or rechargeable Ni-MH batteries (size AA) can be used. METREL recommends only using rechargeable batteries with a capacity of 2100mAh or above.
- ❑ Unpredictable chemical processes can occur during the charging of battery cells that have been left unused for a longer period (more than 6 months). In this case METREL recommends repeating the charge/discharge cycle at least 2-4 times.
- ❑ If no improvement is achieved after several charge / discharge cycles, then each battery cell should be checked (by comparing battery voltages, testing them in a cell charger, etc). It is very likely that only some of the battery cells are deteriorated. One different battery cell can cause an improper behaviour of the entire battery pack!

- The effects described above should not be confused with the normal decrease of battery capacity over time. Battery also loses some capacity when it is repeatedly charged / discharged. This information is provided in the technical specification from battery manufacturer.

## 2.3 Standards applied

The Eurotest instruments are manufactured and tested in accordance with the following regulations:

---

### **Electromagnetic compatibility (EMC)**

EN 61326 Electrical equipment for measurement, control and laboratory use – EMC requirements  
Class B (Hand-held equipment used in controlled EM environments)

---

### **Safety (LVD)**

EN 61010-1 Safety requirements for electrical equipment for measurement, control and laboratory use – Part 1: General requirements

EN 61010-2-030 Safety requirements for electrical equipment for measurement, control and laboratory use – Part 2-030: Particular requirements for testing and measuring circuits

EN 61010-031 Safety requirements for electrical equipment for measurement, control and laboratory use – Part 031: Safety requirements for hand-held probe assemblies for electrical measurement and test

EN 61010-2-032 Safety requirements for electrical equipment for measurement, control, and laboratory use - Part 2-032: Particular requirements for hand-held and hand-manipulated current sensors for electrical test and measurement

---

### **Functionality**

EN 61557 Electrical safety in low voltage distribution systems up to 1000 V<sub>AC</sub> and 1500 V<sub>AC</sub> – Equipment for testing, measuring or monitoring of protective measures  
Part 1: General requirements  
Part 2: Insulation resistance  
Part 3: Loop resistance  
Part 4: Resistance of earth connection and equipotential bonding  
Part 5: Resistance to earth  
Part 6: Residual current devices (RCDs) in TT and TN systems  
Part 7: Phase sequence  
Part 10: Combined measuring equipment  
Part 12: Performance measuring and monitoring devices (PMD)

DIN 5032 Photometry  
Part 7: Classification of illuminance meters and luminance meters

---

### **Reference standards for electrical installations and components**

EN 61008 Residual current operated circuit-breakers without integral overcurrent protection for household and similar uses

EN 61009 Residual current operated circuit-breakers with integral overcurrent protection for household and similar uses

IEC 60364-4-41 Electrical installations of buildings Part 4-41 Protection for safety – protection against electric shock

BS 7671 IEE Wiring Regulations (18<sup>th</sup> edition)

AS/NZS 3017 Electrical installations – Verification guidelines

---

#### **Note about EN and IEC standards:**

- Text of this manual contains references to European standards. All standards of EN 6XXXX (e.g. EN 61010) series are equivalent to IEC standards with the same number (e.g. IEC 61010) and differ only in amended parts required by European harmonization procedure.

## 3 Instrument description

### 3.1 Front panel

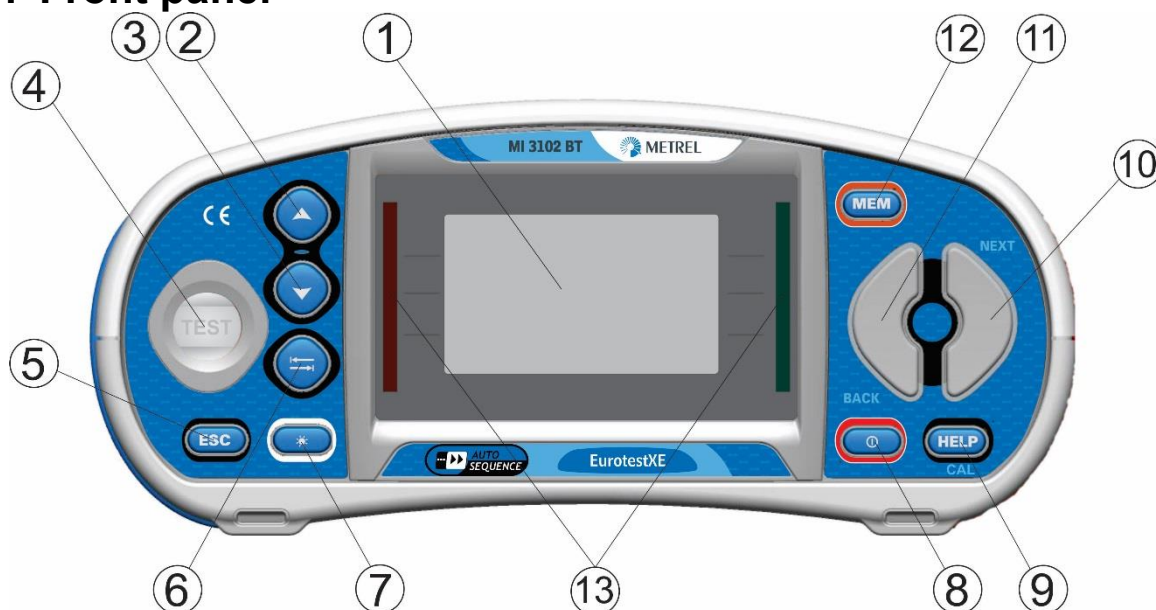

Figure 3.1: Front panel

Legend:

1	<b>LCD</b>	128 x 64 dots matrix display with backlight.
2	<b>UP</b>	Modifies selected parameter.
3	<b>DOWN</b>	Modifies selected parameter.
4	<b>TEST</b>	TEST Starts measurements. Acts also as the PE touching electrode.
5	<b>ESC</b>	Goes one level back.
6	<b>TAB</b>	Selects the parameters in selected function.
7	<b>Backlight Contrast</b>	Changes backlight level and contrast.
8	<b>ON / OFF</b>	Switches the instrument power on or off. The instrument automatically turns off 15 minutes after the last key was pressed.
9	<b>HELP / CAL</b>	Accesses help menus. Calibrates test leads in Continuity functions. Starts $Z_{REF}$ measurement in Voltage drop sub-function.
10	<b>Function selector - RIGHT</b>	Selects test / measurement function.
11	<b>Function selector - LEFT</b>	Selects test / measurement function.
12	<b>MEM</b>	Stores / recalls memory of instrument. Stores clamp settings.
13	<b>Green LEDs Red LEDs</b>	Indicates PASS / FAIL of result.

### 3.2 Connector panel

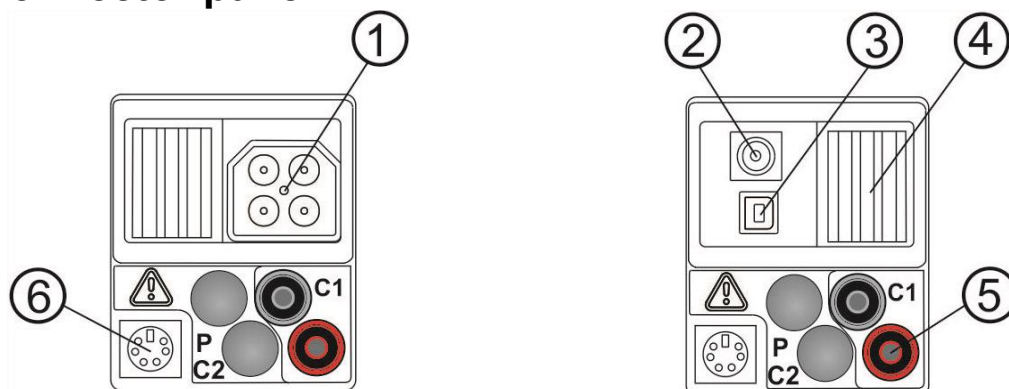

Figure 3.2: Connector panel

Legend:

1	<b>Test connector</b>	Measuring inputs / outputs.
2	<b>Charger socket</b>	
3	<b>USB connector</b>	Communication with PC USB (1.1) port.
4	<b>Protection cover</b>	
5	<b>C1</b>	Current clamp measuring input
		Communication with PC serial port
6	<b>PS/2 connector</b>	Connection to optional measuring adapters
		Connection to barcode / RFID reader



#### Warnings!

- ❑ Maximum allowed voltage between any test terminal and ground is 600 V!
- ❑ Maximum allowed voltage between test terminals on test connector is 600 V!
- ❑ Maximum allowed voltage on test terminal C1 is 3 V!
- ❑ Maximum short-term voltage of external power supply adapter is 14 V!

### 3.3 Back side

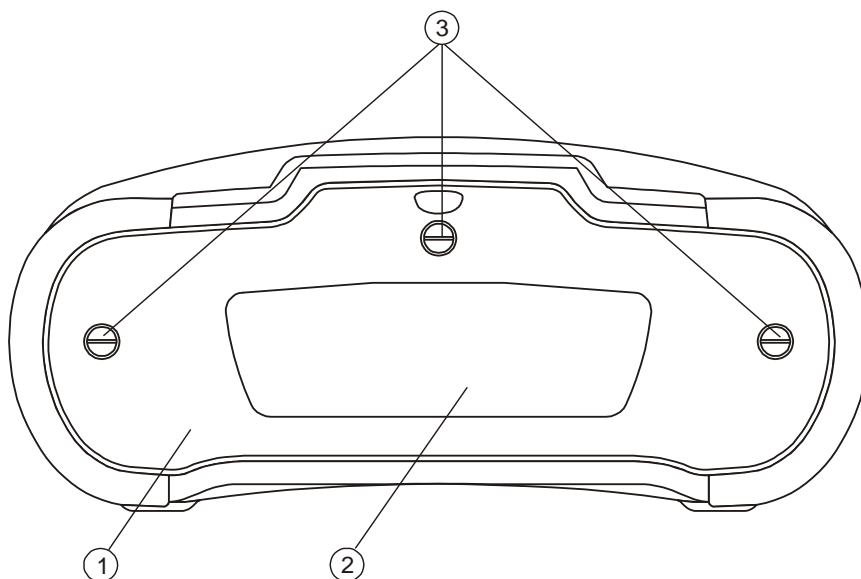

Figure 3.3: Back panel

Legend:

1	<b>Battery / fuse compartment cover</b>
2	<b>Back panel information label</b>
3	<b>Fixing screws for battery / fuse compartment cover</b>

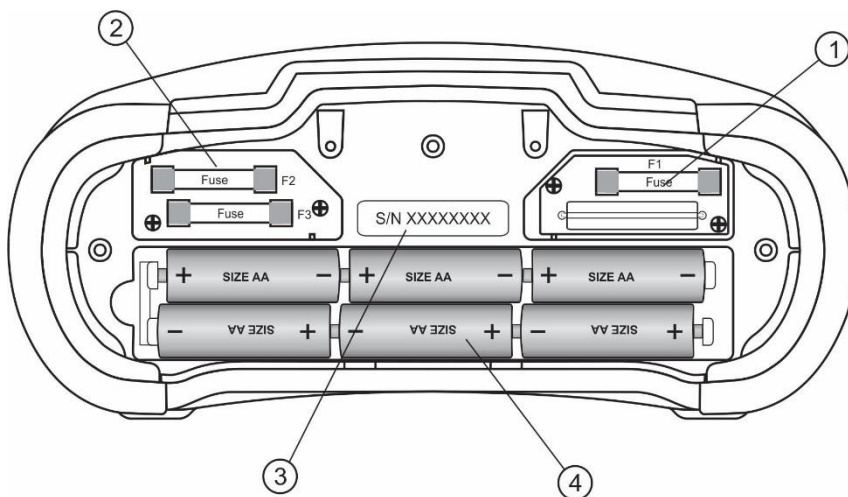

Figure 3.4: Battery and fuse compartment

Legend:

1	<b>Fuse F1</b>	M 315 mA / 250 V
2	<b>Fuses F2 and F3</b>	F 4 A / 500 V (breaking capacity 50 kA)
3	<b>Serial number label</b>	
4	<b>Battery cells</b>	Size AA, alkaline / rechargeable NiMH



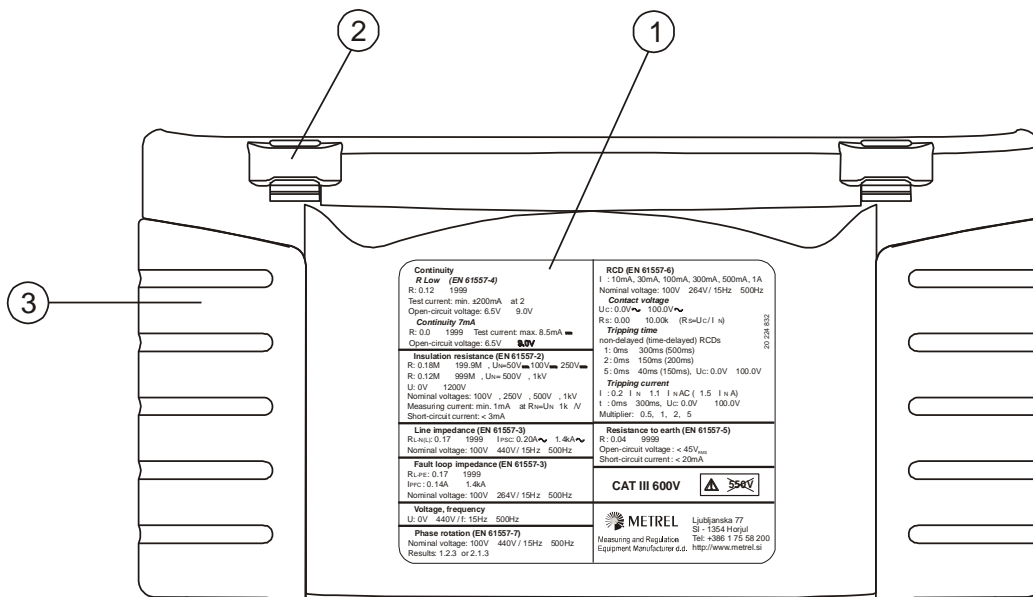

Figure 3.5: Bottom

Legend:

- 1 Bottom information label
- 2 Neck belt openings
- 3 Handling side covers

### 3.4 Carrying the instrument

With the neck-carrying belt supplied in standard set, various possibilities of carrying the instrument are available. Operator can choose appropriate one on basis of his operation, see the following examples:



The instrument hangs around operators neck only – quick placing and displacing.



The instrument can be used even when placed in soft carrying bag – test cable connected to the instrument through the front aperture.

### 3.5 Instrument set and accessories

#### 3.5.1 Standard set MI 3102H BT – EurotestXE

- Instrument
- Soft carrying bag
- Earth set 3-wire, 20 m
- Plug commander
- Test lead, 3 x 1.5 m
- 2.5 kV test lead, 2 x 1.5 m
- Test probe, 3 pcs
- Crocodile clip, 3 pcs
- Set of carrying straps
- RS232-PS/2 cable
- USB cable
- Set of Ni-MH battery cells
- Power supply adapter
- CD with instruction manual, “Guide for testing and verification of low voltage installations” handbook and PC software EurolinkPRO.
- Short instruction manual
- Calibration Certificate

### 3.5.2 Standard set MI 3102 BT – EurotestXE

- Instrument
- Soft carrying bag
- Earth set 3-wire, 20 m
- Plug commander
- Test lead, 3 x 1.5 m
- Test probe, 3 pcs
- Crocodile clip, 3 pcs
- Set of carrying straps
- RS232-PS/2 cable
- USB cable
- Set of Ni-MH battery cells
- Power supply adapter
- CD with instruction manual, “Guide for testing and verification of low voltage installations” handbook and PC software EurolinkPRO.
- Short instruction manual
- Calibration Certificate

### 3.5.3 Optional accessories

See the attached sheet for a list of optional accessories that are available on request from your distributor.

## 4 Instrument operation

### 4.1 Display and sound

#### 4.1.1 Terminal voltage monitor

The terminal voltage monitor displays on-line the voltages on the test terminals and information about active test terminals in the a.c. installation measuring mode.

	Online voltages are displayed together with test terminal indication. All three test terminals are used for selected measurement.
	Online voltages are displayed together with test terminal indication. L and N test terminals are used for selected measurement.
	L and PE are active test terminals; N terminal should also be connected for correct input voltage condition.
	Polarity of test voltage applied to the output terminals, L and N.
	2.5 kV Insulation measurement terminal screen. (MI 3102H BT only)

#### 4.1.2 Battery indication















The battery indication indicates the charge condition of battery and connection of external charger.

	Battery capacity indication.
	Low battery. Battery is too weak to guarantee correct result. Replace or recharge the battery cells.
	Charging in progress (if power supply adapter is connected).



#### 4.1.3 Messages

In the message field warnings and messages are displayed.

	Measurement is running, consider displayed warnings.
	Conditions on the input terminals allow starting the measurement; consider other displayed warnings and messages.
	Conditions on the input terminals do not allow starting the measurement, consider displayed warnings and messages.
	RCD tripped-out during the measurement (in RCD functions).
	Portable RCD selected (PRCD).
	EV RCD selected (Electrical Vehicle RCD).
	MI RCD selected (Mobile Installation RCD).

	Instrument is overheated. The measurement is prohibited until the temperature decreases under the allowed limit.
	Result(s) can be stored.
	High electrical noise was detected during measurement. Results may be impaired.
	L and N are changed.
	<b>Warning!</b> High voltage is applied to the test terminals.
	<b>Warning!</b> Dangerous voltage on the PE terminal! Stop the activity immediately and eliminate the fault / connection problem before proceeding with any activity!
	Test leads resistance in Continuity measurement is not compensated.
	Test leads resistance in Continuity measurement is compensated.
	High resistance to earth of test probes. Results may be impaired.
	Too small current for declared accuracy. Results may be impaired. Check in Current Clamp Settings if sensitivity of current clamp can be increased.
	Measured signal is out of range (clipped). Results are impaired.
	Single fault condition in IT system. (MI 3102 BT only)
	Fuse F1 is broken.
	<b>Warning!</b> Too high DC voltage ( > 50 V DC ) is applied to the test terminals!
<b>DC VOLTAGE!</b>	

#### 4.1.4 Results

	Measurement result is inside pre-set limits (PASS).
	Measurement result is out of pre-set limits (FAIL).
	Measurement is aborted. Consider displayed warnings and messages.

#### 4.1.5 Sound warnings

Continuous sound      **Warning!** Dangerous voltage on the PE terminal is detected.

### 4.1.6 Help screens

<b>HELP</b>	Opens help screen.
-------------	--------------------

Help menus are available in all functions. The Help menu contains schematic diagrams for illustrating how to properly connect the instrument to electric installation. After selecting the measurement, you want to perform, press the HELP key in order to view the associated Help menu.

Keys in help menu:

<b>UP / DOWN</b>	Selects next / previous help screen.
<b>ESC / HELP / Function selector</b>	Exits help menu.

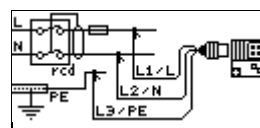
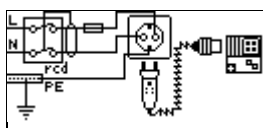

Figure 4.1: Examples of help screens

### 4.1.7 Backlight and contrast adjustments

With the **BACKLIGHT** key backlight and contrast can be adjusted.

<b>Click</b>	Toggles backlight intensity level.
Keep pressed for <b>1 s</b>	Locks high intensity backlight level until power is turned off or the key is pressed again.
Keep pressed for <b>2 s</b>	Bar graph for LCD contrast adjustment is displayed.

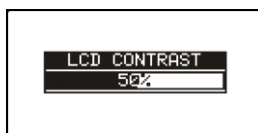

Figure 4.2: Contrast adjustment menu

Keys for contrast adjustment:

<b>DOWN</b>	Reduces contrast.
<b>UP</b>	Increases contrast.
<b>TEST</b>	Accepts new contrast.
<b>ESC</b>	Exits without changes.

## 4.2 Function selection

For selecting test / measurement function within each test mode the **function selector** keys shall be used.

Keys:

<b>Function selector</b>	Selects test / measurement function.
<b>UP / DOWN</b>	Selects sub-function in selected measurement function.
<b>TAB</b>	Selects the test parameter to be set or modified.
<b>TEST</b>	Runs selected test / measurement function.
<b>MEM</b>	Stores measured results / recalls stored results.
<b>ESC</b>	Exits back to main menu.

Keys in **test parameter** field:

<b>UP / DOWN</b>	Changes the selected parameter.
<b>TAB</b>	Selects the next measuring parameter.
<b>Function selector</b>	Toggles between the main functions.
<b>MEM</b>	Stores measured results / recalls stored results

General rule regarding enabling **parameters** for evaluation of measurement / test result:

Parameter	<b>OFF</b>	No limit values, indication: _ _ _.
	<b>ON</b>	<b>Value(s)</b> – results will be marked as PASS or FAIL in accordance with selected limit.

See chapter 5 **Measurements** for more information about the operation of the instrument test functions.

## 4.3 Instruments main menu

In instrument's main menu the test mode can be selected. Different instrument options can be set in the **SETTINGS** menu.

- <INSTALLATION>** a.c. LV installation testing
- <AUTO SEQUENCES>** custom configured autosequences
- <OTHERS>** other tests / measurements
- <SETTINGS>** Instrument settings

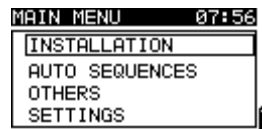

Figure 4.3: Main menu

Keys:

<b>UP / DOWN</b>	Selects appropriate option.
<b>TEST</b>	Enters selected option.

## 4.4 Settings

Different instrument options can be set in the **SETTINGS** menu.

Options are:

- recalling and clearing stored results,
- selection of language,
- setting the date and time,
- setting earthing system (MI 3102 BT only),
- selection of reference standard for RCD tests,
- entering Isc factor,
- commander support,
- setting the instrument and Bluetooth module to initial values,
- settings for current clamps,
- settings of length units for specific earth resistance ( $\rho$ ).

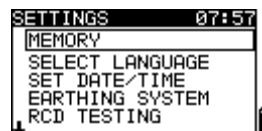

Figure 4.4: Options in Settings menu

Keys:

<b>UP / DOWN</b>	Selects appropriate option.
<b>TEST</b>	Enters selected option.
<b>ESC / Function selector</b>	Exits back to main menu.



### 4.4.1 Memory

In this menu the stored data can be recalled or deleted. See chapter 7 **Data handling** for more information.

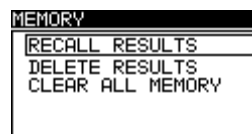

Figure 4.5: Memory options

Keys:

<b>UP / DOWN</b>	Selects option.
<b>TEST</b>	Enters selected option.
<b>ESC</b>	Exits back to settings menu.
<b>Function selector</b>	Exits back to main menu without changes.

### 4.4.2 Language

In this menu the language can be set.

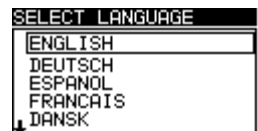

Figure 4.6: Language selection

Keys:

<b>UP / DOWN</b>	Selects language.
<b>TEST</b>	Confirms selected language and exits to settings menu.
<b>ESC</b>	Exits back to settings menu.
<b>Function selector</b>	Exits back to main menu without changes.

### 4.4.3 Date and time

In this menu date and time can be set.

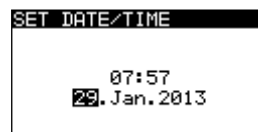

Figure 4.7: Setting date and time

Keys:

<b>TAB</b>	Selects the field to be changed.
<b>UP / DOWN</b>	Modifies selected field.
<b>TEST</b>	Confirms new date / time and exits.
<b>ESC</b>	Exits back to settings menu.
<b>Function selector</b>	Exits back to main menu without changes.

**Note:**

- If the batteries are removed for more than 1 minute the set date and time will be lost.

#### 4.4.4 Earthing system (MI 3102 BT only)

In this menu the earthing system can be set.

Options are:

- TN/TT,
- IT.

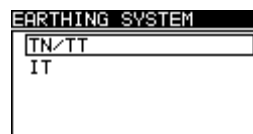

Figure 4.8: Selection of earthing system

Keys:

<b>UP / DOWN</b>	Selects option.
<b>TEST</b>	Confirms selected option and exits to settings menu.
<b>ESC</b>	Exits back to settings menu.
<b>Function selector</b>	Exits back to main menu without changes.

#### 4.4.5 RCD testing

In this menu the used standard for RCD tests can be set.

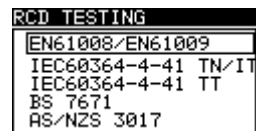

Figure 4.9: Selection of RCD test standard

Keys:

<b>UP / DOWN</b>	Selects standard.
<b>TEST</b>	Confirms selected standard.
<b>ESC</b>	Exits back to settings menu.
<b>Function selector</b>	Exits back to main menu without changes.

Maximum RCD disconnection times differ in various standards. The trip-out times defined in individual standards are listed below.

Trip-out times according to EN 61008 / EN 61009:

	$\frac{1}{2} \times I_{\Delta N}^{(*)}$	$I_{\Delta N}$	$2 \times I_{\Delta N}$	$5 \times I_{\Delta N}$
General RCDs (non-delayed)	$t_{\Delta} > 300 \text{ ms}$	$t_{\Delta} < 300 \text{ ms}$	$t_{\Delta} < 150 \text{ ms}$	$t_{\Delta} < 40 \text{ ms}$
Selective RCDs (time-delayed)	$t_{\Delta} > 500 \text{ ms}$	$130 \text{ ms} < t_{\Delta} < 500 \text{ ms}$	$60 \text{ ms} < t_{\Delta} < 200 \text{ ms}$	$50 \text{ ms} < t_{\Delta} < 150 \text{ ms}$

Test according to standard IEC/HD 60364-4-41 has two selectable options:

- IEC 60364-4-41 TN/IT** and
- IEC 60364-4-41 TT**

The options differ to maximum disconnection times as defined in IEC/HD 60364-4-41 Table 41.1.

Trip-out times according to IEC/HD 60364-4-41:

	$U_0^{***})$	$\frac{1}{2} \times I_{\Delta N}^{(*)}$	$I_{\Delta N}$	$2 \times I_{\Delta N}$	$5 \times I_{\Delta N}$
<b>TN / IT</b>	$\leq 120 \text{ V}$	$t_{\Delta} > 800 \text{ ms}$	$t_{\Delta} \leq 800 \text{ ms}$	$t_{\Delta} < 150 \text{ ms}$	$t_{\Delta} < 40 \text{ ms}$
	$\leq 230 \text{ V}$	$t_{\Delta} > 400 \text{ ms}$	$t_{\Delta} \leq 400 \text{ ms}$		
<b>TT</b>	$\leq 120 \text{ V}$	$t_{\Delta} > 300 \text{ ms}$	$t_{\Delta} \leq 300 \text{ ms}$		
	$\leq 230 \text{ V}$	$t_{\Delta} > 200 \text{ ms}$	$t_{\Delta} \leq 200 \text{ ms}$		

Trip-out times according to BS 7671:

	$\frac{1}{2} \times I_{\Delta N}$ <sup>*)</sup>	$I_{\Delta N}$	$2 \times I_{\Delta N}$	$5 \times I_{\Delta N}$
General RCDs (non-delayed)	$t_{\Delta} > 1999$ ms	$t_{\Delta} < 300$ ms	$t_{\Delta} < 150$ ms	$t_{\Delta} < 40$ ms
Selective RCDs (time-delayed)	$t_{\Delta} > 1999$ ms	$130$ ms $< t_{\Delta} < 500$ ms	$60$ ms $< t_{\Delta} < 200$ ms	$50$ ms $< t_{\Delta} < 150$ ms

Trip-out times according to AS/NZS 3017<sup>\*\*) :</sup>

RCD type	$I_{\Delta N}$ [mA]	$\frac{1}{2} \times I_{\Delta N}$ <sup>*)</sup> $t_{\Delta}$	$I_{\Delta N}$ $t_{\Delta}$	$2 \times I_{\Delta N}$ $t_{\Delta}$	$5 \times I_{\Delta N}$ $t_{\Delta}$	Note
I	$\leq 10$	$> 999$ ms	40 ms	40 ms	40 ms	Maximum break time
II	$> 10 \leq 30$		300 ms	150 ms	40 ms	
III	$> 30$		300 ms	150 ms	40 ms	
IV $\text{S}$	$> 30$	$> 999$ ms	500 ms 130 ms	200 ms 60 ms	150 ms 50 ms	Minimum non-actuating time

<sup>\*)</sup> Minimum test period for current of  $\frac{1}{2} \times I_{\Delta N}$ , RCD shall not trip-out.

<sup>\*\*)</sup> Test current and measurement accuracy correspond to AS/NZS 3017 requirements.

<sup>\*\*\*)</sup>  $U_0$  is nominal  $U_{LPE}$  voltage.

Maximum test times related to selected test current for general (non-delayed) RCD

Standard	$\frac{1}{2} \times I_{\Delta N}$	$I_{\Delta N}$	$2 \times I_{\Delta N}$	$5 \times I_{\Delta N}$
EN 61008 / EN 61009	300 ms	300 ms	150 ms	40 ms
EN 60364-4-41	1000 ms	1000 ms	150 ms	40 ms
BS 7671	2000 ms	300 ms	150 ms	40 ms
AS/NZS 3017 (I, II, III)	1000 ms	1000 ms	150 ms	40 ms

Maximum test times related to selected test current for selective (time-delayed) RCD

Standard	$\frac{1}{2} \times I_{\Delta N}$	$I_{\Delta N}$	$2 \times I_{\Delta N}$	$5 \times I_{\Delta N}$
EN 61008 / EN 61009	500 ms	500 ms	200 ms	150 ms
EN 60364-4-41	1000 ms	1000 ms	200 ms	150 ms
BS 7671	2000 ms	500 ms	200 ms	150 ms
AS/NZS 3017 (IV)	1000 ms	1000 ms	200 ms	150 ms

**Note:**

- Trip-out limit times for PRCD, PRCD-K and PRCD-S are equal to General (non-delayed) RCDs.

#### 4.4.6 Isc factor

In this menu the Isc factor for calculation of short circuit current in Z-LINE and Z-LOOP measurements can be set.

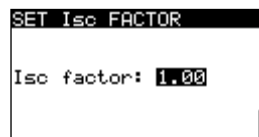

Figure 4.10: Selection of Isc factor

Keys:

<b>UP / DOWN</b>	Sets Isc value.
<b>TEST</b>	Confirms Isc value.
<b>ESC</b>	Exits back to settings menu.
<b>Function selectors</b>	Exits back to main menu without changes.

Short circuit current Isc in the supply system is important for selection or verification of protective circuit breakers (fuses, over-current breaking devices, RCDs).

The default value of Isc factor (ksc) is 1.00. The value should be set according to local regulative.

Range for adjustment of the Isc factor is 0.20 ÷ 3.00.

#### 4.4.7 Commander support

The support for remote commanders can be enabled or disabled in this menu.

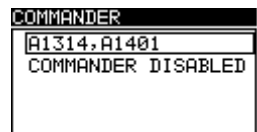

Figure 4.11: Selection of commander support

Keys:

<b>UP / DOWN</b>	Selects commander option.
<b>TEST</b>	Confirms selected option.
<b>ESC</b>	Exits back to settings menu.
<b>Function selector</b>	Exits back to main menu without changes.

**Note:**

- Commander disabled option is intended to disable the commander's remote keys. In the case of high EM interfering noise the operation of the commander can be irregular.

### 4.4.8 Initial settings

In this menu the instrument settings, measurement parameters and limits can be set to initial (factory) values.

Internal Bluetooth module is initialized.

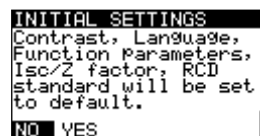

Figure 4.12: Initial settings dialogue

Keys:



<b>UP / DOWN</b>	Selects option [YES, NO].
<b>TEST</b>	Restores default settings (if YES is selected).
<b>ESC</b>	Exits back to settings menu.
<b>Function selector</b>	Exits back to main menu without changes.

#### Warnings:

- Customized settings will be lost when this option is used!
- If the batteries are removed for more than 1 minute the custom made settings will be lost.

The default setup is listed below:

Instrument setting	Default value
Language	English
Contrast	As defined and stored by adjustment procedure
Earthing system*	TN/TT
Length units	m
Isc factor	1.00
RCD standards	EN 61008 / EN 61009
Commander	A 1314, A 1401
Internal bluetooth	Initialization of internal Bluetooth module
Clamp settings	A1391, 40A
Test mode:	
Function	Parameters / limit value
Sub-function	
EARTH RE, 2 clamps	No limit
EARTH $\rho$	2.0 m
R ISO	No limit Nominal test voltage: 500 V
Low Ohm Resistance	
R LOW $\Omega$	No limit
CONTINUITY	No limit, sound OFF
Rpe	No limit
Rpe(rcd)	No limit
Z - LINE	Fuse type: none selected
VOLTAGE DROP	$\Delta U$ : 4.0 % $Z_{REF}$ : 0.00 $\Omega$
Z - LOOP	Fuse type: none selected
Zs rcd	Fuse type: none selected
RCD	RCD t

	Nominal differential current: $I_{\Delta N}=30$ mA RCD type: AC, non-delayed Test current starting polarity:  (0°) Limit contact voltage: 50 V Current multiplier: $\times 1$
AUTO SEQUENCES:	
AUTO TT	FUSE: None selected $Z_{REF}$ : --- $\Delta U$ : 4.0 % RCD: 30 mA, AC, non-delayed,  (0°) $U_c$ : 50 V
AUTO TN (rcd)	FUSE: None selected $Z_{REF}$ : --- $\Delta U$ : 4.0 % R <sub>pe</sub> : No limit
AUTO TN	FUSE: None selected $Z_{REF}$ : --- $\Delta U$ : 4.0 % R <sub>pe</sub> : No limit
AUTO IT*	FUSE: None selected $Z_{REF}$ : --- $\Delta U$ : 4.0 % ISFL: 3.0 mA IMD: AUTO R, 35 k $\Omega$ , 2 s
OTHERS:	
HARMONICS	U h:1
SENSOR	No limit
ISFL*	No limit
IMD*	AUTO R, 30 k $\Omega$ , 2 s
DIAG. TEST**	Nominal test voltage: 500 V

\* MI 3102 BT only

\*\* MI 3102H BT only

**Note:**

- Initial settings (reset of the instrument) can be recalled also if the TAB key is pressed while the instrument is switched on.

#### 4.4.9 Clamp Settings

In **Clamp settings menu** the C1 measuring input can be configured.



Figure 4.13: Configuration of current clamp measuring input

**Parameters to be set:**

<b>Model</b>	<b>Model of current clamp</b> [A1018, A1019, A1391].
<b>Range</b>	<b>Measuring range of current clamp</b> [20 A], [40 A, 300 A].

### Selection of measuring parameters

Keys:

<b>UP / DOWN</b>	Selects appropriate option.
<b>TEST</b>	Enables changing data of selected parameter.
<b>MEM</b>	Saves settings.
<b>ESC</b>	Exits back to clamp settings menu.
<b>Function selector</b>	Exits back to main menu without changes.

### Changing data of selected parameter

Keys:

<b>UP / DOWN</b>	Sets parameter.
<b>TEST</b>	Confirms set data.
<b>MEM</b>	Saves settings.
<b>ESC</b>	Disable changing data of selected parameter.
<b>Function selector</b>	Exits back to main menu without changes.

**Note:**

- Measuring range of the instrument must be considered. Measurement range of current clamp can be higher than of the instrument.

## 4.4.10 Length units

Length unit for specific earth resistance measurement can be selected in this menu.

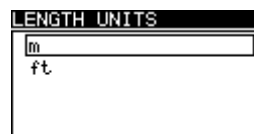

Figure 4.14: Selection of length unit

Keys:

<b>UP / DOWN</b>	Selects length unit.
<b>TEST</b>	Confirms selected option.
<b>ESC</b>	Exits back to settings menu.
<b>Function selector</b>	Exits back to main menu without changes.

# 5 Measurements

## 5.1 Voltage, frequency and phase sequence

Voltage and frequency measurement is always active in the terminal voltage monitor. In the special **VOLTAGE TRMS** menu the measured voltage, frequency and information about detected three-phase connection can be stored. Measurements are based on the EN 61557-7 standard.

See chapter 4.2 **Function** selection for instructions on key functionality.

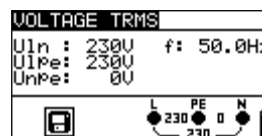

Figure 5.1: Voltage in single phase system

### Test parameters for voltage measurement

There are no parameters to be set.

### Connections for voltage measurement

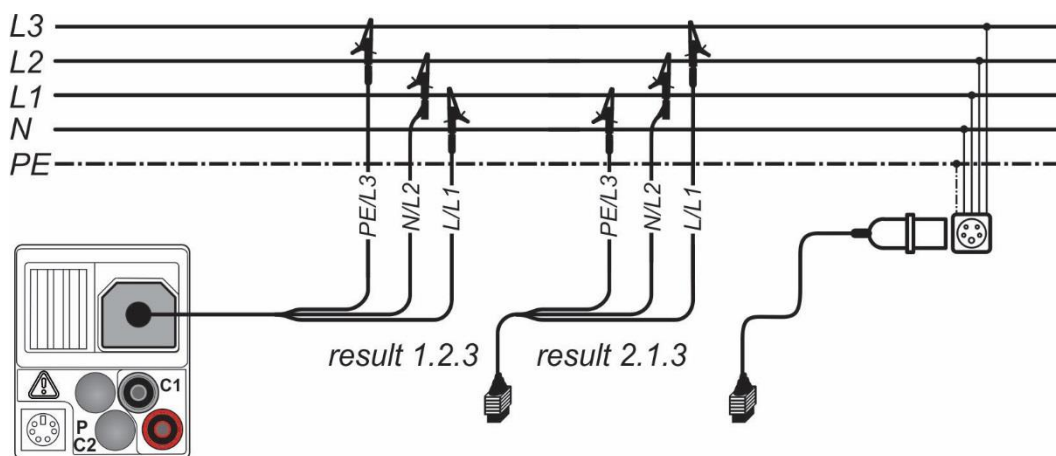

Figure 5.2: Connection of 3-wire test lead and optional adapter in three-phase system

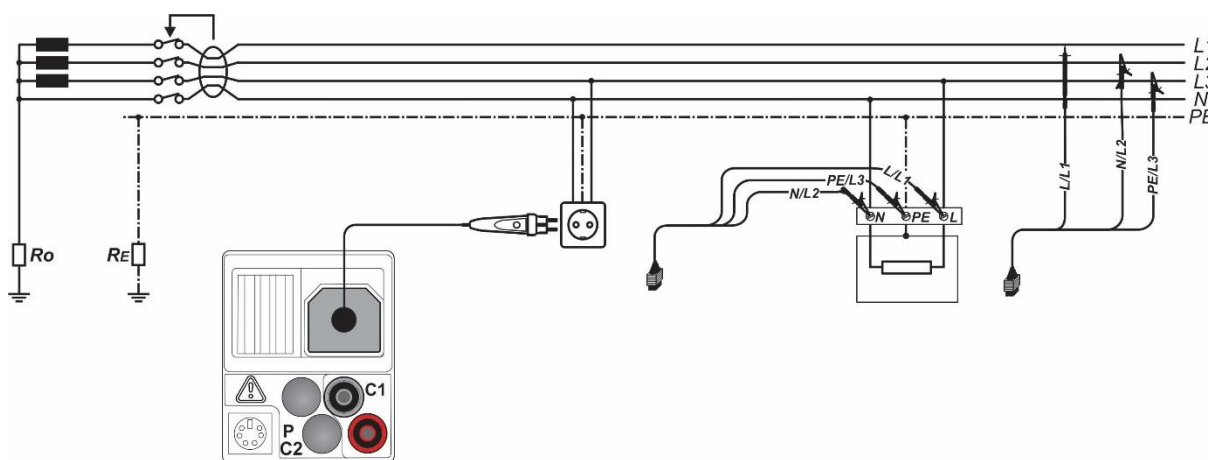

Figure 5.3: Connection of plug commander and 3-wire test lead in single-phase system



### Voltage measurement procedure

- ❑ Select the **VOLTAGE TRMS** function using the function selector keys.
- ❑ **Connect** test cable to the instrument.
- ❑ **Connect** test leads to the item to be tested (see *Figure 5.2* and *Figure 5.3*).
- ❑ **Store** voltage measurement result by pressing the **MEM** key (optional).

Measurement runs immediately after selection of **VOLTAGE TRMS** function.



Figure 5.4: Examples of voltage measurement in three-phase system

Displayed results for single phase system:

- U<sub>ln</sub>** ..... voltage between phase and neutral conductors
- U<sub>lpe</sub>** ..... voltage between phase and protective conductors
- U<sub>npe</sub>** ..... voltage between neutral and protective conductors
- f** ..... frequency

Displayed results for three-phase system:

- U<sub>12</sub>** ..... voltage between phases L1 and L2
- U<sub>13</sub>** ..... voltage between phases L1 and L3
- U<sub>23</sub>** ..... voltage between phases L2 and L3
- 1.2.3** ..... correct connection – CW rotation sequence
- 3.2.1** ..... invalid connection – CCW rotation sequence
- f** ..... frequency

Displayed results for IT system (MI 3102 BT only):

- U<sub>12</sub>** ..... voltage between phases L1 and L2
- U<sub>1pe</sub>** ..... voltage between phase L1 and protective conductor
- U<sub>2pe</sub>** ..... voltage between phase L2 and protective conductor
- f** ..... frequency

## 5.2 Insulation resistance

The insulation resistance measurement is performed in order to ensure safety against electric shock through insulation. Typical applications are:

- ❑ insulation resistance between conductors of installation,
- ❑ insulation resistance of non-conductive rooms (walls and floors),
- ❑ insulation resistance of ground cables and
- ❑ resistance of semi-conductive (antistatic) floors.

See chapter **4.2 Function** selection for instructions on key functionality.

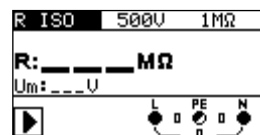

Figure 5.5: Insulation resistance

### Test parameters for insulation resistance measurement

<b>Uiso</b>	<b>Nominal test voltage</b> [50 V, 100 V, 250 V, 500 V, 1000 V, 2500 V*]
<b>Limit</b>	<b>Minimum insulation resistance</b> [OFF, 0.01 MΩ ÷ 200 MΩ]

\* Nominal test voltage 2500 V is available on MI 3102H BT only.

### Test circuits for insulation resistance

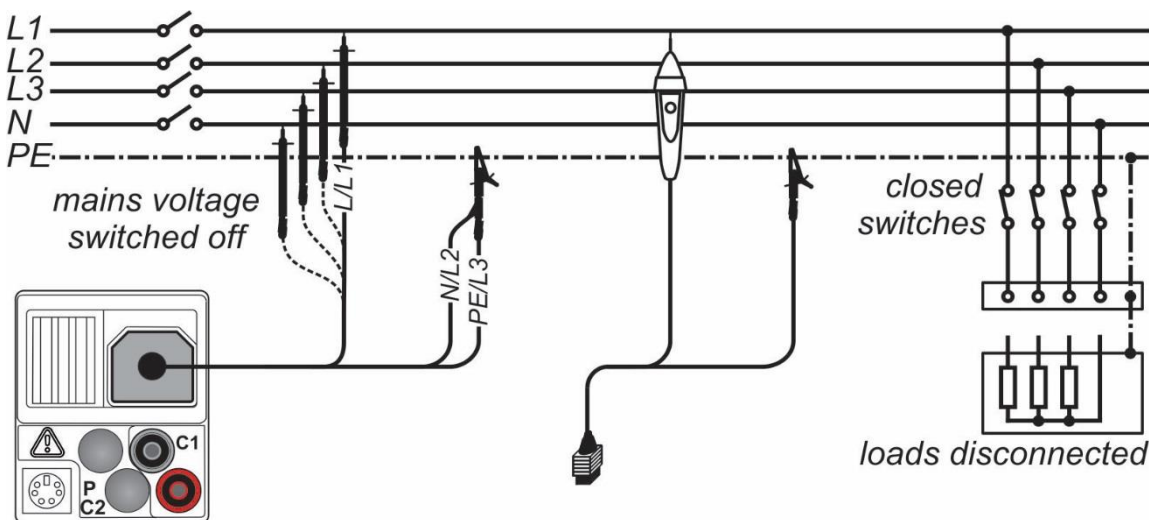

Figure 5.6: Connection of 3-wire test lead and tip commander ( $U_N \leq 1 \text{ kV}$ )

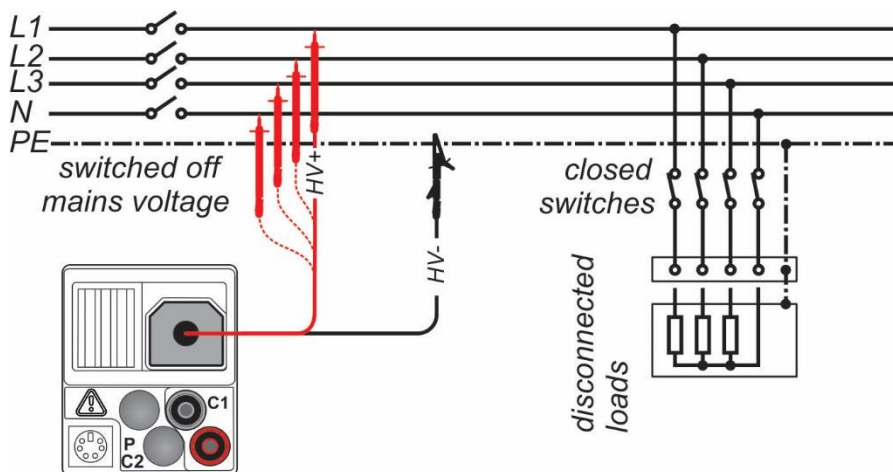

Figure 5.7: Connection of 2.5 kV test lead ( $U_N=2.5\text{ kV}$ )

**Insulation resistance measuring procedure**

- ❑ Select the **R ISO** function using the function selector keys.
  - ❑ Set the required **test voltage**.
  - ❑ Enable and set **limit** value (optional).
  - ❑ **Disconnect** tested installation from mains supply (and discharge insulation as required).
  - ❑ **Connect** test cable to the instrument and to the item to be tested (see Figure 5.6 and Figure 5.7).
- Different test cable must be used for testing with nominal test voltage  $U_N \leq 1000\text{ V}$  and  $U_N = 2500\text{ V}$ . Also, different test terminals are used.
- The standard three-wire test lead, schuko test cable or plug / tip commanders can be used for the insulation test with nominal test voltages  $\leq 1000\text{ V}$ . For the 2500 V insulation test the two wire 2.5 kV test lead should be used.
- ❑ Press the **TEST** key to perform the measurement (double click for continuous measurement and later press to stop the measurement).
  - ❑ After the measurement is finished wait until tested item is fully discharged.
  - ❑ **Store** the result by pressing the **MEM** key (optional).

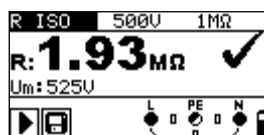

Figure 5.8: Example of insulation resistance measurement result

Displayed results:

- R** ..... insulation resistance
- Um** ..... test voltage (actual value)

### 5.3 The DAR and PI diagnostic (MI 3102H BT only)

Analysing the changes in the measured insulation resistance over time and calculating the **DAR** (**D**ielectric **A**bsorption **R**ation) and **PI** (**P**olarization **I**ndex) are very useful maintenance tests of insulating materials.

Diagnostic test is a long duration test for evaluating the quality of the insulation material under test. The results of this test enable the decision to be made on the preventive replacement of the insulation material.

**DAR** is ratio of insulation resistance values measured after 15 seconds and after 1 minute. The DC test voltage is present during the whole period of the measurement.

$$DAR = \frac{R_{iso}(1\ min)}{R_{iso}(15\ s)}$$

**PI** is the ratio of insulation resistance values measured after 1 minute and after 10 minutes. The DC test voltage is present during the whole period of the measurement

$$PI = \frac{R_{iso}(10\ min)}{R_{iso}(1\ min)}$$

For additional information regarding PI and DAR diagnostic, please refer to Metrel's handbook **Modern insulation testing**.

See chapter **4.2 Function** selection for instructions on key functionality.

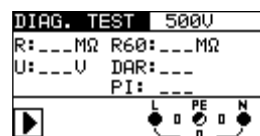

Figure 5.9: Diagnostic tests menu

#### Test parameter for diagnostic tests

Uiso	Nominal test voltage [500 V, 1000 V, 2500 V]
------	--

## Diagnostic tests procedure

- ❑ Select the **DIAG. TEST** function from the **OTHERS** menu.
  - ❑ Set the nominal test voltage.
  - ❑ **Connect** test cable to the instrument and to the item to be tested (see *Figure 5.6 and Figure 5.7*).
- Different test cable must be used for testing with nominal test voltage  $U_N \leq 1000$  V and  $U_N = 2500$  V. Also, different test terminals are used.
- The standard three-wire test lead, schuko test cable or plug / tip commanders can be used for the diagnostic test with nominal test voltages  $\leq 1000$  V. For the 2500 V diagnostic test the two wire 2.5 kV test lead should be used.
- ❑ Press the **TEST** key to start the measurement. Internal timer begins to increment. When internal timer reaches 1 min R60 and DAR factor are displayed and short beep is generated.
  - ❑ When internal timer reaches 10 min also PI factor is displayed and measurement is completed. (Measurement can be interrupted any time by pressing the **TEST** key again.)
  - ❑ After the measurement is finished wait until tested item is fully discharged.
  - ❑ **Store** the result by pressing the **MEM** key (optional).



Figure 5.10: Example of PI and DAR diagnostic test results

Displayed results:

- R** ..... insulation resistance
- U** ..... test voltage (actual value)
- R60** ..... resistance after 60 seconds
- DAR** ..... dielectric absorption ratio
- PI** ..... polarization index

**Notes:**

- ❑ Diagnostic tests are available only for nominal test voltages 500 V, 1000 V and 2500V.
- ❑ If any insulation resistance values ( $R_{ISO}(15s)$  or  $R_{ISO}(1min)$ ) are over-ranged the DAR factor is not calculated. The result field is blank: DAR : \_ \_ \_ !
- ❑ If any insulation resistance values ( $R_{ISO}(1min)$  or  $R_{ISO}(10min)$ ) are over-ranged the PI factor is not calculated. The result field is blank: PI : \_ \_ \_ !

## 5.4 Resistance of earth connection and equipotential bonding

The resistance measurement is performed in order to ensure that the protective measures against electric shock through earth connections and bondings are effective. Two sub-functions are available:

- R LOWΩ - Earth bond measurement according to EN 61557-4 (200 mA) and
- CONTINUITY - Continuous resistance measurement performed with 7 mA.

See chapter 4.2 **Function** selection for instructions on key functionality.

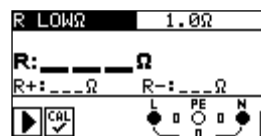

Figure 5.11: 200 mA RLOW Ω

### Test parameters for resistance measurement

<b>Test</b>	<b>Resistance measurement sub-function [R LOWΩ, CONTINUITY]</b>
<b>Limit</b>	<b>Maximum resistance [OFF, 0.1 Ω ÷ 20.0 Ω]</b>

### Additional test parameter for Continuity sub-function

	<b>Buzzer On</b> (sound if resistance is lower than the set limit value) or Off
--	---

Additional key:

<b>HELP</b>	<i>Click</i>	Calibrates test leads in Continuity functions.
	<i>Keep pressed for 1s</i>	Enters Help screen

### 5.4.1 R LOWΩ, 200 mA resistance measurement

The resistance measurement is performed with automatic polarity reversal of the test voltage.

#### Test circuit for R LOWΩ measurement

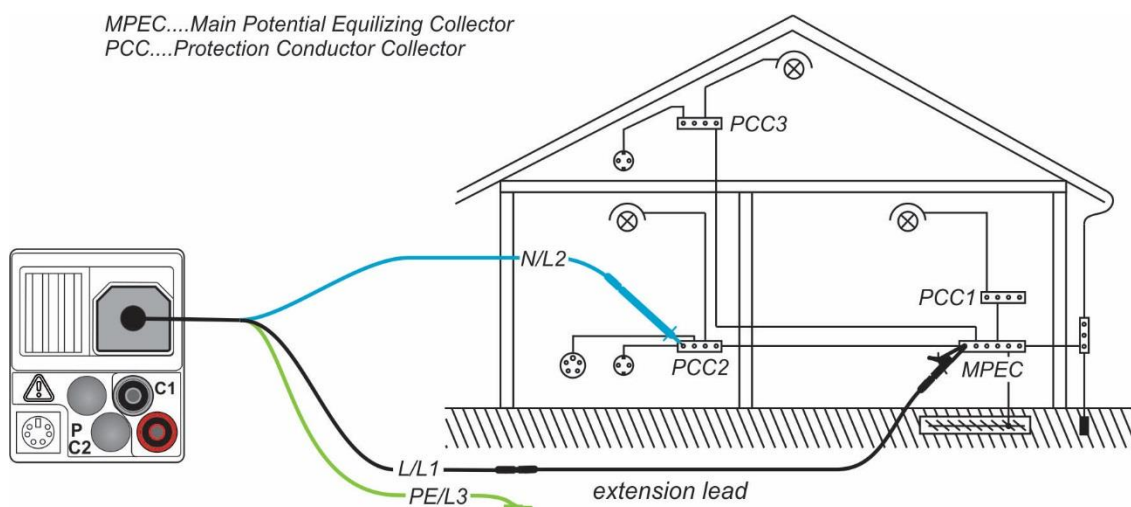

Figure 5.12: Connection of 3-wire test lead plus optional extension lead

**R LOW $\Omega$  measurement procedure**

- ❑ Select continuity function using the function selector keys.
- ❑ Set sub-function to **R LOW $\Omega$**  using **UP / DOWN** keys.
- ❑ Enable and set **limit** (optional).
- ❑ **Connect** test cable to the instrument.
- ❑ **Compensate** the test leads resistance if necessary, (see section 5.4.3 *Compensation of test leads resistance*).
- ❑ **Disconnect** from mains supply and discharge installation to be tested.
- ❑ **Connect** the test leads to the appropriate PE wiring (see *Figure 5.12*).
- ❑ Press the **TEST** key to perform the measurement.
- ❑ After the measurement is finished **store** the result by pressing the **MEM** button (optional).



Figure 5.13: Example of RLOW result

Displayed result:

- R** ..... R LOW $\Omega$  resistance
- R+** ..... result at positive polarity
- R-** ..... result at negative test polarity

### 5.4.2 Continuous resistance measurement with low current

In general, this function serves as standard  $\Omega$ -meter with a low testing current. The measurement is performed continuously without polarity reversal. The function can also be applied for testing continuity of inductive components.

#### Test circuit for continuous resistance measurement

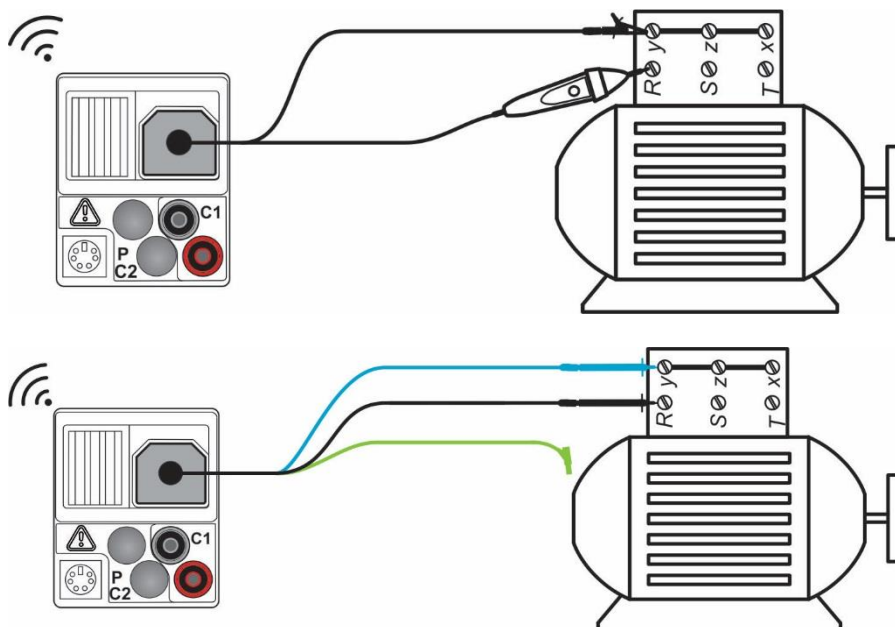

Figure 5.14: Tip commander and 3-wire test lead applications

#### Continuous resistance measurement procedure

- ❑ Select continuity function using the function selector keys.
- ❑ Set sub-function to **CONTINUITY** using **UP / DOWN** keys.
- ❑ Enable and set the **limit** (optional).
- ❑ **Connect** test cable to the instrument.
- ❑ **Compensate** test leads resistance if necessary, (see section 5.4.3 Compensation of test leads resistance).
- ❑ **Disconnect** from mains supply and discharge the object to be tested.
- ❑ **Connect** test leads to the tested object (see Figure 5.14).
- ❑ Press the **TEST** key to begin performing a continuous measurement.
- ❑ Press the **TEST** key to stop measurement.
- ❑ After the measurement is finished **store** the result by pressing the **MEM** key (optional).

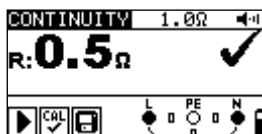

Figure 5.15: Example of continuous resistance measurement

Displayed result:

R ..... resistance



### 5.4.3 Compensation of test leads resistance

This chapter describes how to compensate the test leads resistance in both continuity functions, R LOW $\Omega$  and CONTINUITY. Compensation is required to eliminate the influence of test leads resistance and the internal resistances of the instrument on the measured resistance. The lead compensation is therefore a very important feature to obtain correct result.



symbol is displayed if the compensation was carried out successfully.

#### Circuits for compensating the resistance of test leads

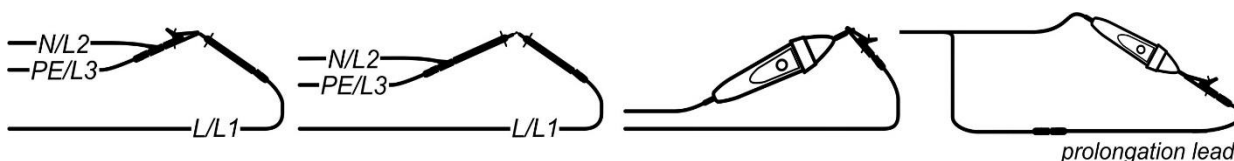

Figure 5.16: Shorted test leads

#### Compensation of test leads resistance procedure

- Select **R LOW $\Omega$**  or **CONTINUITY** function.
- Connect** test cable to the instrument and short the test leads together (see Figure 5.16).
- Press the **TEST** key to perform resistance measurement.
- Press the **CAL** key to compensate leads resistance.

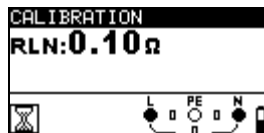

Figure 5.17: Results with old calibration values

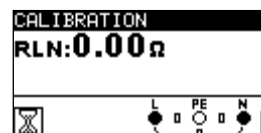

Figure 5.18: Results with new calibration values

#### Note:

- The highest value for lead compensation is 5  $\Omega$ . If the resistance is higher the compensation value is set back to default value.



is displayed if no calibration value is stored.

## 5.5 Testing RCDs

Various test and measurements are required for verification of RCD(s) in RCD protected installations. Measurements are based on the EN 61557-6 standard.

The following measurements and tests (sub-functions) can be performed:

- contact voltage,
- trip-out time,
- trip-out current and
- RCD auto-test.

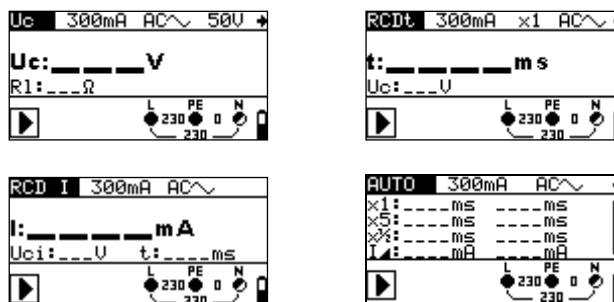

See chapter 4.2 **Function** selection for instructions on key functionality.

Figure 5.19: RCD tests

### Test parameters for RCD test and measurement

TEST	RCD sub-function test [Uc, RCDt, RCD I, AUTO]
$I_{\Delta N}$	<b>Rated RCD residual current sensitivity <math>I_{\Delta N}</math></b> [10 mA, 30 mA, 100 mA, 300 mA, 500 mA, 1000 mA].
type	<b>RCD type</b> [AC, A, F, B*, B*+]. <b>Starting polarity</b> [~ , ~ , ~ , ~ , ~ , ~* , ~*+]. <b>Property selection</b> [selective <input checked="" type="checkbox"/> , general non-delayed <input type="checkbox"/> , PRCD, PRCD-K, PRCD-S, MI RCD*, EV RCD*].
MUL	<b>Multiplication factor for test current</b> [ $\frac{1}{2}$ , 1, 2, 5 $I_{\Delta N}$ ].
Ulim	<b>Conventional touch voltage limit</b> [25 V, 50 V].

\* Model MI 3102 BT only

#### Notes:

- Ulim can be selected in the Uc sub-function only.
- Selective (time-delayed) RCDs have delayed response characteristics. As the contact voltage pre-test or other RCD tests influence the time delayed RCD it takes a certain period to recover into normal state. Therefore, a time delay of 30 s is inserted before performing trip-out test by default.
- Portable RCDs (PRCD, PRCD-K and PRCD-S) are tested as general (non-delayed) RCDs. Trip-out times, trip-out currents and contact voltage limits are equal to limits of general (non-delayed) RCDs.
- The a.c. part of MI and EV RCDs is tested as general (non-delayed) RCDs.
- The d.c. part of MI and EV RCDs is tested with a d. c. test current. The Pass limit is between 0.5 and 1.0  $I_{dNDC}$ .

Connections for testing RCD

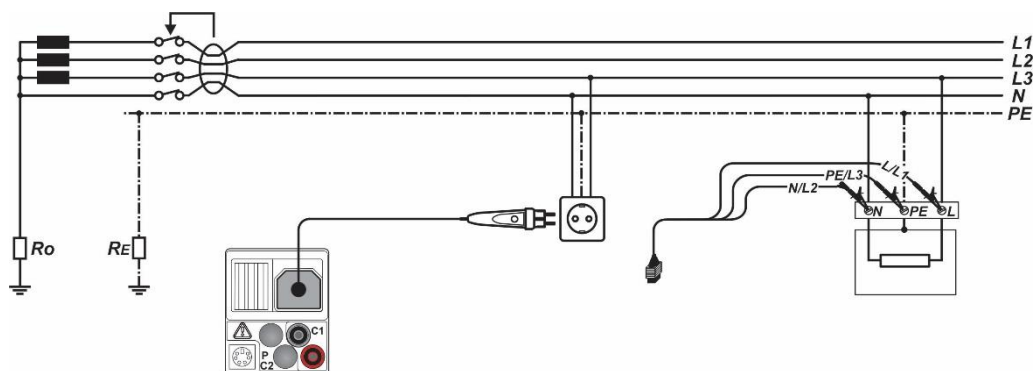

Figure 5.20: Connecting the plug commander and the 3-wire test lead

5.5.1 Contact voltage (RCD Uc)

A current flowing into the PE terminal causes a voltage drop on earth resistance, i.e. voltage difference between PE equipotential bonding circuit and earth. This voltage difference is called contact voltage and is present on all accessible conductive parts connected to the PE. It shall always be lower than the conventional safety limit voltage.

The contact voltage is measured with a test current lower than  $\frac{1}{2} I_{\Delta N}$  to avoid trip-out of the RCD and then normalized to the rated  $I_{\Delta N}$ .

Contact voltage measurement procedure

- Select the **RCD** function using the function selector keys.
- Set sub-function to **Uc** using **UP / DOWN** keys.
- Set test **parameters** (if necessary).
- Connect** test cable to the instrument.
- Connect** test leads to the item to be tested (see *Figure 5.20*).
- Press the **TEST** key to perform the measurement.
- Store** the result by pressing the **MEM** key (optional).

The contact voltage result relates to the rated nominal residual current of the RCD and is multiplied by an appropriate factor (depending on RCD type and type of test current). The 1.05 factor is applied to avoid negative tolerance of result. See *Table 5.1* for detailed contact voltage calculation factors.

RCD type		Contact voltage Uc proportional to	Rated $I_{\Delta N}$	Notes
AC, EV, MI (a.c. part)	<input type="checkbox"/>	$1.05 \times I_{\Delta N}$	any	All models
AC	<input checked="" type="checkbox"/>	$2 \times 1.05 \times I_{\Delta N}$	$\geq 30 \text{ mA}$	
A, F	<input type="checkbox"/>	$1.4 \times 1.05 \times I_{\Delta N}$		
A, F	<input checked="" type="checkbox"/>	$2 \times 1.4 \times 1.05 \times I_{\Delta N}$	$< 30 \text{ mA}$	
A, F	<input type="checkbox"/>	$2 \times 1.05 \times I_{\Delta N}$		
A, F	<input checked="" type="checkbox"/>	$2 \times 2 \times 1.05 \times I_{\Delta N}$	any	Model MI 3102 BT only
B, B+	<input type="checkbox"/>	$2 \times 1.05 \times I_{\Delta N}$		
B, B+	<input checked="" type="checkbox"/>	$2 \times 2 \times 1.05 \times I_{\Delta N}$		

Table 5.1: Relationship between  $U_c$  and  $I_{\Delta N}$

Loop resistance is indicative and calculated from  $U_c$  result (without additional proportional factors) according to:  $R_L = \frac{U_c}{I_{\Delta N}}$ .

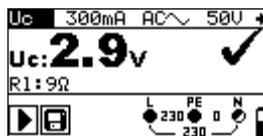

Figure 5.21: Example of contact voltage measurement results

Displayed results:

**Uc** .....contact voltage

**RI** .....fault loop resistance

## 5.5.2 Trip-out time (RCDt)

Trip-out time measurement verifies the sensitivity of the RCD at different residual currents.

### Trip-out time measurement procedure

- Select the **RCD** function using the function selector keys.
- Set sub-function to **RCDt** using **UP / DOWN** keys.
- Set test **parameters** (if necessary).
- Connect** test cable to the instrument.
- Connect** test leads to the item to be tested (see *Figure 5.20*).
- Press the **TEST** key to perform the measurement.
- Store** the result by pressing the **MEM** key (optional).

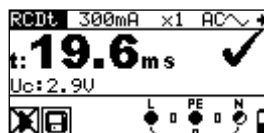

Figure 5.22: Example of trip-out time measurement results

Displayed results:

**t** .....trip-out time

**Uc** .....contact voltage for rated  $I_{\Delta N}$

### 5.5.3 Trip-out current (RCD I)

A continuously rising residual current is intended for testing the threshold sensitivity for RCD trip-out. The instrument increases the test current in small steps through appropriate range as follows:

RCD type	Slope range		Waveform	Notes
	Start value	End value		
<b>AC</b>	$0.2 \times I_{\Delta N}$	$1.1 \times I_{\Delta N}$	Sine	All models
<b>A, F (<math>I_{\Delta N} \geq 30</math> mA)</b>	$0.2 \times I_{\Delta N}$	$1.5 \times I_{\Delta N}$	Pulsed	
<b>A, F (<math>I_{\Delta N} = 10</math> mA)</b>	$0.2 \times I_{\Delta N}$	$2.2 \times I_{\Delta N}$		
<b>EV, MI (a.c. part)</b>	$0.2 \times I_{\Delta N}$	$1.1 \times I_{\Delta N}$	Sine	Model MI 3102BT only
<b>B, B+, EV, MI (d.c. part)</b>	$0.2 \times I_{\Delta N}$	$2.2 \times I_{\Delta N}$	DC	

Maximum test current is  $I_{\Delta}$  (trip-out current) or end value in case the RCD didn't trip-out.

#### Trip-out current measurement procedure

- Select the **RCD** function using the function selector keys.
- Set sub-function to **RCD I** using **UP / DOWN** keys.
- Set test **parameters** (if necessary).
- Connect** test cable to the instrument.
- Connect** test leads to the item to be tested (see *Figure 5.20*).
- Press the **TEST** key to perform the measurement.
- Store** the result by pressing the **MEM** key (optional).

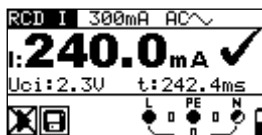

Figure 5.23: Trip-out current measurement result example

Displayed results:

I .....trip-out current

Uci .....contact voltage at trip-out current I or end value in case the RCD didn't trip

t .....trip-out time

### 5.5.4 RCD Auto-test

RCD auto-test function is intended to perform a complete RCD test (trip-out time at different residual currents, trip-out current and contact voltage) in one set of automatic tests, guided by the instrument.

**Additional key:**

HELP	Click	Toggles between top and bottom part of results field.
	Keep pressed for 1s	Enters Help screen

**RCD Auto-test procedure**

RCD Auto-test steps	Notes
<ul style="list-style-type: none"> <li>❑ Select the <b>RCD</b> function using the function selector keys.</li> <li>❑ Set sub-function to <b>AUTO</b> using <b>UP / DOWN</b> keys.</li> <li>❑ Set test <b>parameters</b> (if necessary).</li> <li>❑ <b>Connect</b> test cable to the instrument.</li> <li>❑ <b>Connect</b> test leads to the item to be tested (see <i>Figure 5.20</i>).</li> <li>❑ Press the <b>TEST</b> key to perform the test.</li> </ul>	Start of test
<ul style="list-style-type: none"> <li>❑ Test with <math>I_{\Delta N}, 0^\circ</math> (step 1).</li> </ul>	RCD should trip-out
<ul style="list-style-type: none"> <li>❑ <b>Re-activate RCD.</b></li> <li>❑ Test with <math>I_{\Delta N}, 180^\circ</math> (step 2).</li> </ul>	RCD should trip-out
<ul style="list-style-type: none"> <li>❑ <b>Re-activate RCD.</b></li> <li>❑ Test with <math>5 \times I_{\Delta N}, 0^\circ</math> (step 3).</li> </ul>	RCD should trip-out
<ul style="list-style-type: none"> <li>❑ <b>Re-activate RCD.</b></li> <li>❑ Test with <math>5 \times I_{\Delta N}, 180^\circ</math> (step 4).</li> </ul>	RCD should trip-out
<ul style="list-style-type: none"> <li>❑ <b>Re-activate RCD.</b></li> <li>❑ Test with <math>\frac{1}{2} \times I_{\Delta N}, 0^\circ</math> (step 5).</li> <li>❑ Test with <math>\frac{1}{2} \times I_{\Delta N}, 180^\circ</math> (step 6).</li> </ul>	RCD should not trip-out RCD should not trip-out
<ul style="list-style-type: none"> <li>❑ Trip-out current test, <math>0^\circ</math> (step 7).</li> </ul>	RCD should trip-out
<ul style="list-style-type: none"> <li>❑ <b>Re-activate RCD.</b></li> <li>❑ Trip-out current test, <math>180^\circ</math> (step 8).</li> </ul>	RCD should trip-out
<ul style="list-style-type: none"> <li>❑ <b>Re-activate RCD.</b><sup>1)</sup></li> <li>❑ Trip-out current test, <b>+ DC</b> (step 9).</li> </ul>	RCD should trip-out
<ul style="list-style-type: none"> <li>❑ <b>Re-activate RCD.</b><sup>1)</sup></li> <li>❑ Trip-out current test, <b>- DC</b> (step 10).</li> </ul>	RCD should trip-out
<ul style="list-style-type: none"> <li>❑ <b>Re-activate RCD.</b></li> <li>❑ <b>Store</b> the result by pressing the <b>MEM</b> key (optional).</li> </ul>	End of test

1) Steps 9 and 10 are performed for EV RCD or MI RCD only.

**Result examples:**

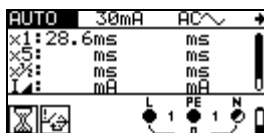

Step 1

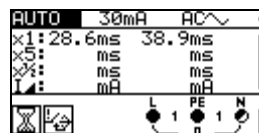

Step 2

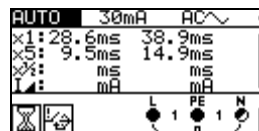
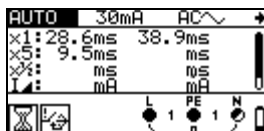

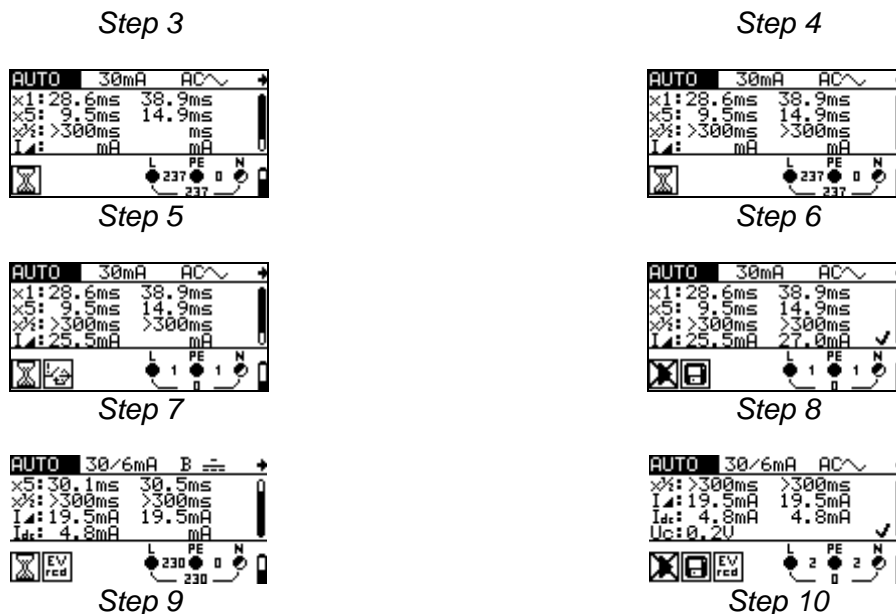

Figure 5.24: Individual steps in RCD auto-test



Figure 5.25: Two parts of result field in RCD auto-test

Displayed results:

- x1 .....step 1 trip-out time ( $I_{\Delta}=I_{\Delta N}, 0^{\circ}$ )
- x1 .....step 2 trip-out time ( $I_{\Delta}=I_{\Delta N}, 180^{\circ}$ )
- x5 .....step 3 trip-out time ( $I_{\Delta}=5 \times I_{\Delta N}, 0^{\circ}$ )
- x5 .....step 4 trip-out time ( $I_{\Delta}=5 \times I_{\Delta N}, 180^{\circ}$ )
- x $\frac{1}{2}$  .....step 5 trip-out time ( $I_{\Delta}=\frac{1}{2} \times I_{\Delta N}, 0^{\circ}$ )
- x $\frac{1}{2}$  .....step 6 trip-out time ( $I_{\Delta}=\frac{1}{2} \times I_{\Delta N}, 180^{\circ}$ )
- I $\perp$  .....step 7 trip-out current ( $0^{\circ}$ )
- I $\perp$  .....step 8 trip-out current ( $180^{\circ}$ )
- Idc .....step 9 trip-out current (+ DC)
- Idc .....step 10 trip-out current (- DC)
- Uc .....contact voltage for rated  $I_{\Delta N}$

**Notes:**

- ❑ The auto-test sequence is immediately stopped if any incorrect condition is detected, e.g. excessive  $U_c$  or trip-out time out of bounds.
- ❑ Auto test is finished without x5 tests in case of testing the RCD types A and F with rated residual currents of  $I_{\Delta N} = 300 \text{ mA}, 500 \text{ mA},$  and  $1000 \text{ mA}$ . In this case auto test result passes if all other results pass, and indications for x5 are omitted.
- ❑ Tests for sensitivity (I $\perp$ , steps 7 and 8) are omitted for selective type RCD.
- ❑ Trip out time measurement for B and B+ type RCDs in AUTO function is made with sine-wave test current, while trip-out current measurement is made with DC test current (MI 3102 BT only).

## 5.6 Fault loop impedance and prospective fault current

Fault loop is a loop comprised by mains source, line wiring and PE path to the mains source. The instrument measures the impedance of the loop and calculates the short circuit current. The measurement is covered by requirements of the EN 61557-3 standard.

See chapter 4.2 **Function** selection for instructions on key functionality.

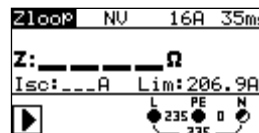

Figure 5.26: Fault loop impedance

### Test parameters for fault loop impedance measurement

<b>Test</b>	Selection of <b>fault loop impedance sub-function</b> [Zloop, Zs rcd]
<b>Fuse type</b>	Selection of <b>fuse type</b> [---, NV, gG, B, C, K, D]
<b>Fuse I</b>	<b>Rated current</b> of selected fuse
<b>Fuse T</b>	<b>Maximum breaking time</b> of selected fuse
<b>Lim</b>	<b>Minimum short circuit current</b> for selected fuse

See Appendix A for reference fuse data.

### Circuits for measurement of fault loop impedance

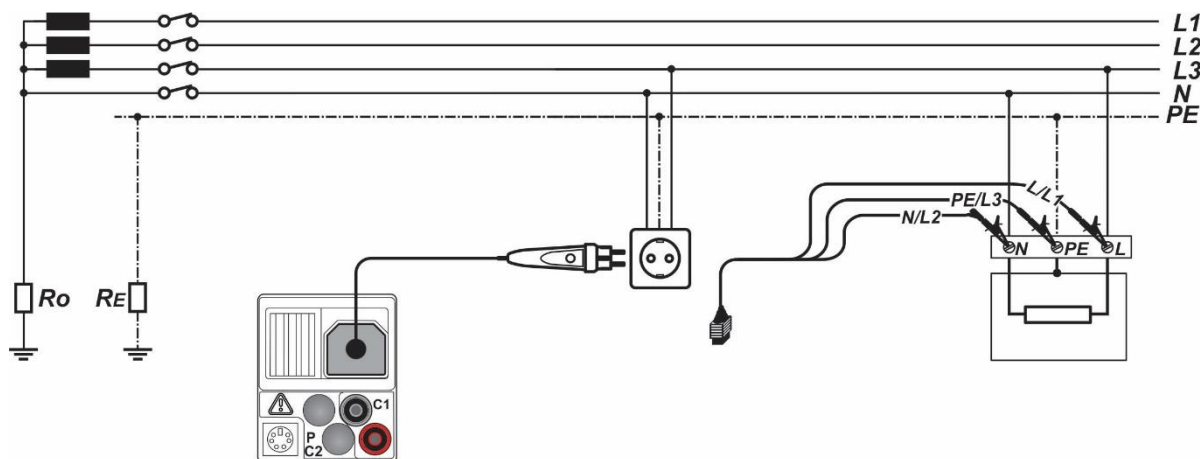

Figure 5.27: Connection of plug commander and 3-wire test lead



**Fault loop impedance measurement procedure**

- ❑ Select the **ZLOOP** function using the function selector keys.
- ❑ Set sub-function to **Zloop** or **Zs rcd** using the **UP / DOWN** keys.
- ❑ Select test **parameters** (optional).
- ❑ **Connect** test cable to the instrument.
- ❑ **Connect** test leads to the item to be tested (see *Figure 5.20* and *Figure 5.27*).
- ❑ Press the **TEST** key to perform the measurement.
- ❑ **Store** the result by pressing the **MEM** key (optional).

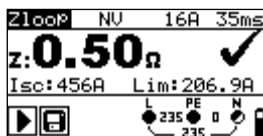

Figure 5.28: Example of loop impedance measurement result

Displayed results:

- Z**..... fault loop impedance
- Isc**..... prospective fault current,
- Lim**..... low limit prospective short-circuit current value

Prospective fault current  $I_{SC}$  is calculated from measured impedance as follows:

$$I_{SC} = \frac{U_n \times k_{SC}}{Z}$$

where:

- $U_n$ ..... Nominal  $U_{L-PE}$  voltage (see table below),
- $k_{sc}$ ..... Correction factor for  $I_{sc}$  (see chapter 4.4.6/sc factor).

$U_n$	Input voltage range (L-PE)
110 V	$(93 V \leq U_{L-PE} \leq 134 V)$
230 V	$(185 V \leq U_{L-PE} \leq 266 V)$

**Notes:**

- ❑ High fluctuations of mains voltage can influence the measurement results (the noise sign  is displayed in the message field). In this case it is recommended to repeat few measurements to check if the readings are stable.
- ❑ This measurement will trip-out the RCD in RCD-protected electrical installation if test Zloop is selected.
- ❑ Select Zs rcd measurement to prevent trip-out of RCD in RCD protected installation.

## 5.7 Line impedance and prospective short-circuit current / Voltage drop

Line impedance is measured in loop comprising of mains voltage source and line wiring. Line impedance is covered by the requirements of the EN 61557-3 standard.

The Voltage drop sub-function is intended to check that a voltage in the installation stays above acceptable levels if the highest current is flowing in the circuit. The highest current is defined as the nominal current of the circuit's fuse. The limit values are described in the standard EN 60364-5-52.

Sub-functions:

- ❑ Z LINE - Line impedance measurement according to EN 61557-3 and
- ❑  $\Delta U$  – Voltage drop measurement.

See chapter **4.2 Function** selection for instructions on key functionality.

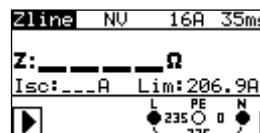

Figure 5.29: Line impedance

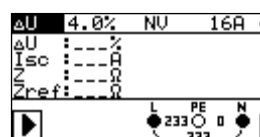

Figure 5.30: Voltage drop

### Test parameters for line impedance measurement

Test	Selection of line impedance [Zline] or voltage drop [ $\Delta U$ ] sub-function
<b>FUSE type</b>	Selection of <b>fuse type</b> [---, NV, gG, B, C, K, D]
<b>FUSE I</b>	<b>Rated current</b> of selected fuse
<b>FUSE T</b>	<b>Maximum breaking time</b> of selected fuse
<b>Lim</b>	<b>Minimum short circuit current</b> for selected fuse.

See Appendix A for reference fuse data.

Additional test parameters for voltage drop measurement

<b><math>\Delta U_{MAX}</math></b>	<b>Maximum voltage drop</b> [3.0 % ÷ 9.0 %].
------------------------------------	--

Additional key:

<b>HELP / CAL</b>	<i>Click</i>	Measures Zref value for $\Delta U$ function.
	<i>Keep pressed for 1s</i>	Enters Help screen.

### 5.7.1 Line impedance and prospective short circuit current

#### Circuits for measurement of line impedance

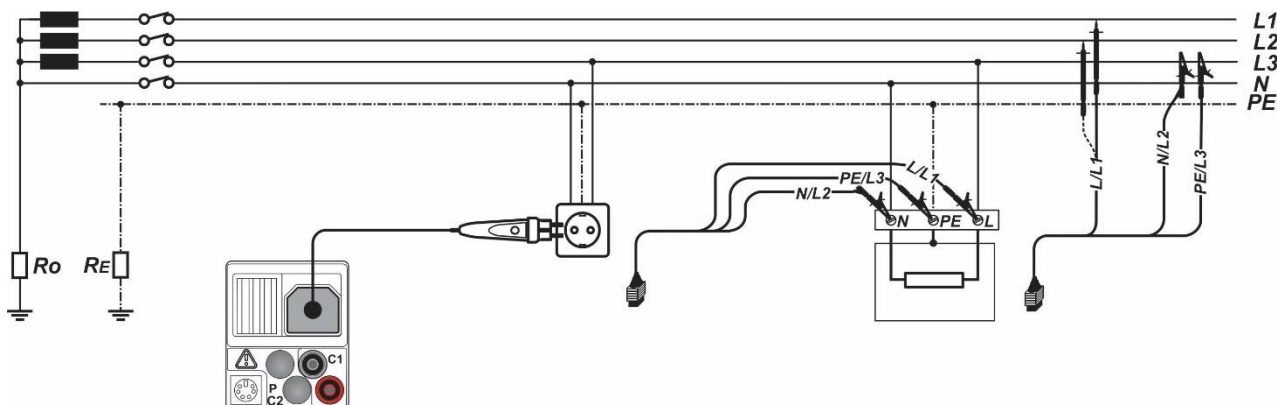

Figure 5.31: Phase-neutral or phase-phase line impedance measurement – connection of plug commander and 3-wire test lead

#### Line impedance measurement procedure

- ❑ Select the **Z LINE** function using the function selector keys.
- ❑ Set sub-function to **Zline** using **UP / DOWN** keys.
- ❑ Select test **parameters** (optional).
- ❑ **Connect** test cable to the instrument.
- ❑ **Connect** test leads to the item to be tested (see Figure 5.31).
- ❑ Press the **TEST** key to perform the measurement.
- ❑ **Store** the result by pressing the **MEM** key (optional).



Figure 5.32: Examples of line impedance measurement result

Displayed results:

- Z**..... line impedance
- Isc** ..... prospective short-circuit current
- Lim**..... low limit prospective short-circuit current value

Prospective short circuit current is calculated as follows:

$$I_{sc} = \frac{U_n \times k_{sc}}{Z}$$

where:

- Un..... Nominal L-N or L1-L2 voltage (see table below),
- ksc..... Correction factor for Isc (see chapter 4.4.6 Isc factor).

Un	Input voltage range (L-N or L1-L2)
110 V	(93 V ≤ U <sub>L-N</sub> < 134 V)
230 V	(185 V ≤ U <sub>L-N</sub> ≤ 266 V)
400 V	(321 V < U <sub>L-L</sub> ≤ 485 V)

**Note:**

- High fluctuations of mains voltage can influence the measurement results (the noise sign  is displayed in the message field). In this case it is recommended to repeat few measurements to check if the readings are stable.

### 5.7.2 Voltage drop

The voltage drop is calculated based on the difference of line impedance at connection points (sockets) and the line impedance at the reference point (usually the impedance at the switchboard).

#### Circuits for measurement of voltage drop

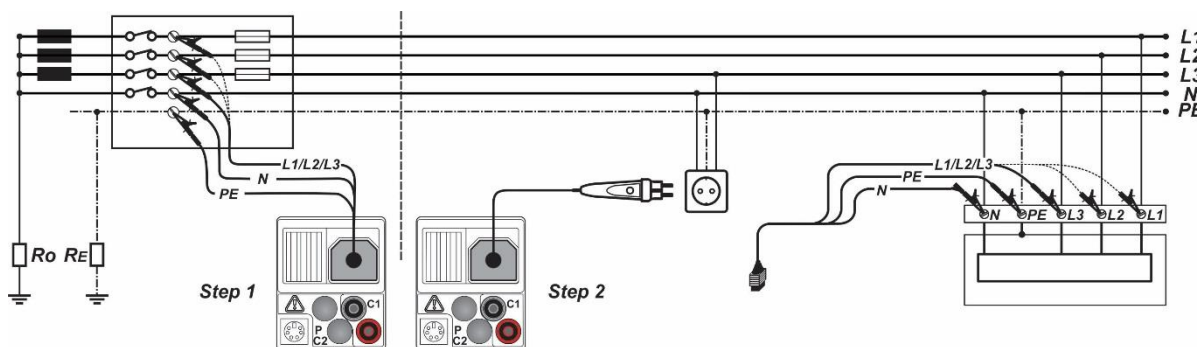

Figure 5.33: Phase-neutral or phase-phase voltage drop measurement – connection of plug commander and 3-wire test lead

#### Voltage drop measurement procedure

##### Step 1: Measuring the impedance Zref at origin

- Select the **Z LINE** function using the function selector keys.
- Set sub-function to **ΔU** using **UP / DOWN** keys.
- Select test **parameters** (optional).
- Connect** test cable to the instrument.
- Connect** the test leads to the origin of electrical installation (see Figure 5.33).
- Press the **CAL** key to perform the measurement.

##### Step 2: Measuring the voltage drop

- Set sub-function to **ΔU** using **UP / DOWN** keys.
- Select test **parameters** (Fuse type must be selected).
- Connect** test cable or plug commander to the instrument.
- Connect** the test leads to the tested points (see Figure 5.33).
- Press the **TEST** key to perform the measurement.
- Store the result by pressing the **MEM** key (optional).

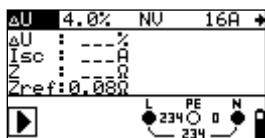

Step 1 - Zref

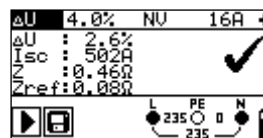

Step 2 - Voltage drop

Figure 5.34: Examples of voltage drop measurement result

Displayed results:

**ΔU** ..... voltage drop  
**I<sub>sc</sub>** ..... prospective short-circuit current  
**Z** ..... line impedance at measured point  
**Z<sub>ref</sub>** ..... reference impedance

Voltage drop is calculated as follows:

$$\Delta U[\%] = \frac{(Z - Z_{REF}) \cdot I_N}{U_N} \cdot 100$$

where:

**ΔU** ..... calculated voltage drop  
**Z** ..... impedance at test point  
**Z<sub>REF</sub>** ..... impedance at reference point  
**I<sub>N</sub>** ..... rated current of selected fuse  
**U<sub>N</sub>** ..... nominal voltage (see table below)

<b>U<sub>n</sub></b>	<b>Input voltage range (L-N or L1-L2)</b>
110 V	(93 V ≤ U <sub>L-N</sub> < 134 V)
230 V	(185 V ≤ U <sub>L-N</sub> ≤ 266 V)
400 V	(321 V < U <sub>L-L</sub> ≤ 485 V)

#### Notes:

- If the reference impedance is not set the value of Z<sub>REF</sub> is considered as 0.00 Ω.
- The Z<sub>REF</sub> is cleared (set to 0.00 Ω) if pressing CAL key while instrument is not connected to a voltage source.
- I<sub>SC</sub> is calculated as described in chapter 5.7.1 *Line impedance and prospective short circuit current*.
- If the measured voltage is outside the ranges described in the table above the ΔU result will not be calculated.
- High fluctuations of mains voltage can influence the measurement results (the noise sign  is displayed in the message field). In this case it is recommended to repeat few measurements to check if the readings are stable.

## 5.8 Earth resistance

Earth resistance is one of the most important parameters for protection against electric shock. Main earthing arrangements, lightning systems, local earthings, soil resistivity, etc can be verified with the earthing resistance test. The measurement conforms to the EN 61557-5 standard.

The Earth resistance main function is divided into three sub-functions:

- ❑ 3-wire earth resistance test RE for standard earth resistance tests with two earthing rods.
- ❑ Contactless earth resistance test with two current clamps (also recommended in IEC 60364-6 for urban areas), for measuring resistance to earth of individual earthing rods.
- ❑ Specific earth resistance.

See chapter **4.2 Function** selection for instructions on key functionality.

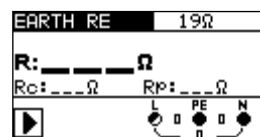

Figure 5.35: Earth resistance

### Test parameters for earth resistance measurement

<b>Test</b>	<b>Test configuration</b> [EARTH RE, two clamps, $\rho$ ]
<b>Limit</b>	<b>Maximum resistance</b> [OFF, 1 $\Omega$ ÷ 5 k $\Omega$ ]
<b>Distance</b>	In $\rho$ sub-function only: <b>Distance between probes</b> [0.1 m ÷ 30.0 m] or [1 ft ÷ 100 ft]

### Earth resistance measurements, common measurement procedure

- ❑ Select **EARTH** function using the function selector keys.
- ❑ Set sub-function to **EARTH RE** or **EARTH 2 CLAMPS** using **UP / DOWN** keys.
- ❑ Enable and set **limit** value (optional).
- ❑ **Connect** test leads to the instrument.
- ❑ **Connect** the item to be tested (see Figure 5.36, Figure 5.37 and Figure 5.39).
- ❑ Press the **TEST** key to perform the measurement.
- ❑ **Store** the result by pressing the **MEM** key (optional).

### 5.8.1 Standard earthing resistance measurement

#### Connections for earth resistance measurement

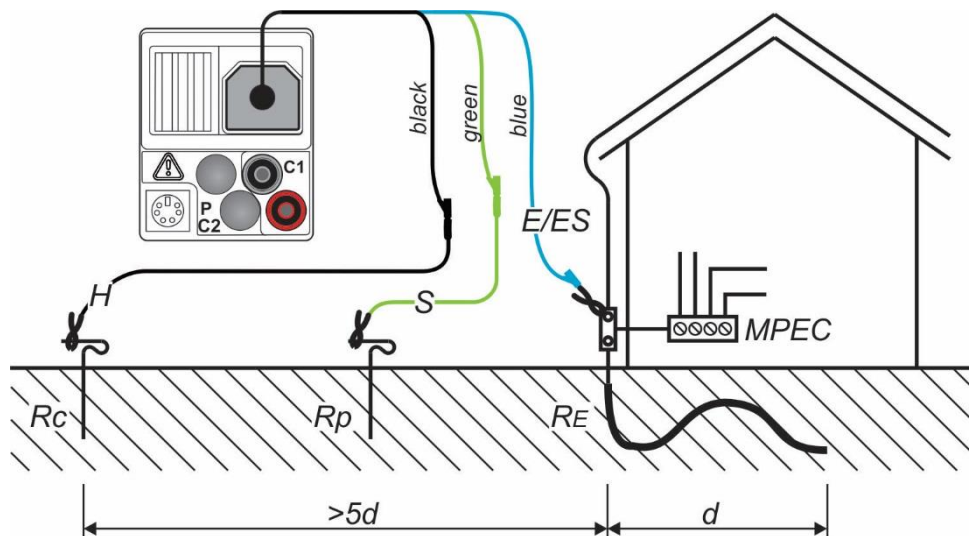

Figure 5.36: Resistance to earth, measurement of main installation earthing

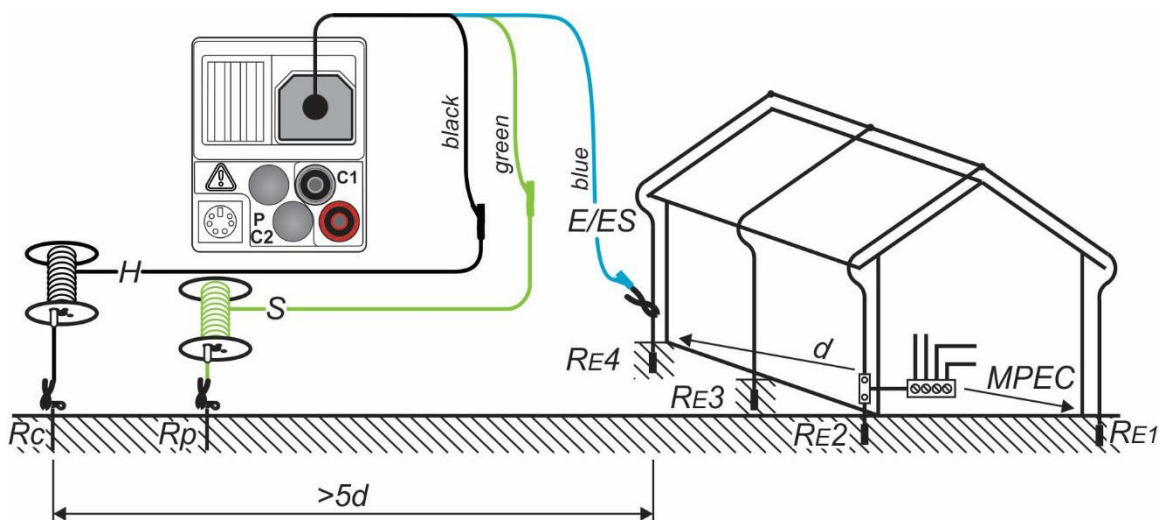

Figure 5.37: Resistance to earth, measurement of a lighting protection system



Figure 5.38: Example of earth resistance measurement result

Displayed results for earth resistance measurement:

- R ..... earth resistance
- R<sub>p</sub> ..... resistance of S (potential) probe
- R<sub>c</sub> ..... resistance of H (current) probe

**Notes:**

- ❑ High resistance of S and H probes could influence the measurement results. In this case, “Rp” and “Rc” warnings are displayed. There is no PASS / FAIL indication in this case.
- ❑ High noise currents and voltages in earth could influence the measurement results. The tester displays the  warning in this case.
- ❑ Probes must be placed at sufficient distance from the measured object.

### 5.8.2 Contactless earthing resistance measurement (with two current clamps)

The measurement enables simple testing of individual earthing rods in large earthing system. It is especially suitable for use in urban areas because there is usually no possibility to place the test probes.

**Connection for contactless earthing resistance measurement**

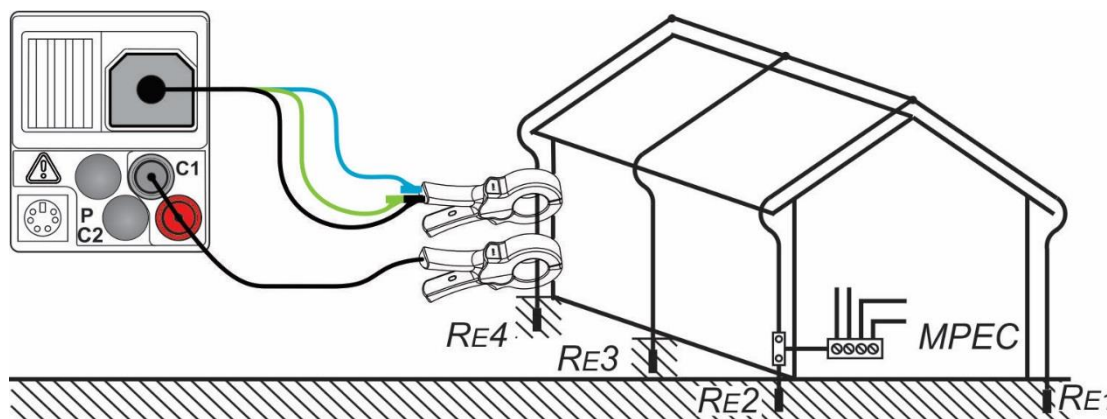

Figure 5.39: Contactless earthing resistance measurement

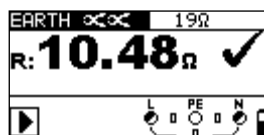

Figure 5.40: Example of contactless earthing resistance measurement result

Displayed results for contactless earth resistance measurement:

R ..... earth resistance

**Notes:**

- ❑ For two clamps earth resistance measurement clamps A 1018 and A 1019 should be used. Clamps A 1391 are not supported.
- ❑ The distance between clamps should be at least 30 cm.
- ❑ High noise currents and voltages in earth could influence the measurement results. The tester displays the “noise” warning in this case.
- ❑ The measurement results are very accurate for resistances below 10 Ω. At higher values (several 10 Ω) the test current drops to few mA. The measuring accuracy for small currents and immunity against noise currents must be considered! The tester displays the “low current” warning in this case.



### 5.8.3 Specific earth resistance measurement

The specific earth resistance (soil resistivity) is measured to determine the characteristic of the soil. The results are used to properly dimension earthing systems (size, depth, number and position of earthing rods).

#### Circuit for specific earth resistance measurement

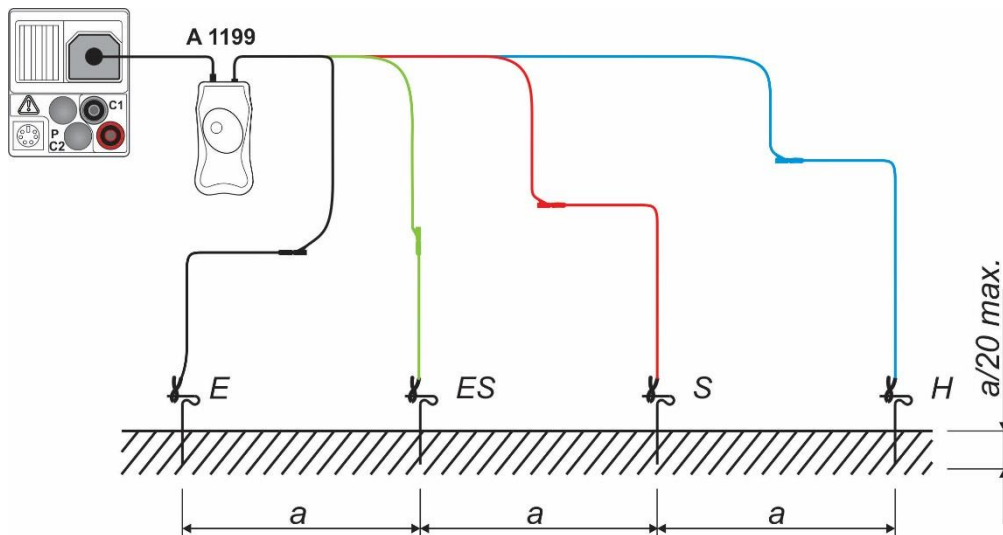

Figure 5.41: Specific earth resistance measurement

#### Specific earth resistance measurement procedure:

- ❑ Select **EARTH** function using the function selector keys.
- ❑ Set sub-function to **EARTH  $\rho$**  using **UP / DOWN** keys.
- ❑ Select the **distance** (a) between test probes.
- ❑ **Connect** A 1199  $\rho$  adapter to the instrument.
- ❑ **Connect** the test leads to earth probes (see Figure 5.41).
- ❑ Press the **TEST** key to perform the measurement.
- ❑ **Store** the result by pressing the **MEM** key (optional).



Figure 5.42: Example of specific earth resistance measurement result

Displayed results for earth resistance measurement:

- $\rho$  ..... specific earth resistance
- Rc** ..... resistance of H, E (current) probe
- Rp** ..... resistance of S, ES (potential) probe

#### Notes:

- ❑ High resistance of S, H, ES, E probes could influence the measurement results. In this case, “Rp” and “Rc” warnings are displayed.
- ❑ High noise currents and voltages in earthing could influence the measurement results. The tester displays the “noise” warning in this case.

### 5.9 PE test terminal

It can happen that a dangerous voltage is applied to the PE wire or other accessible metal parts. This is a very dangerous situation since the PE wire and MPEs are considered to be earthed. An often reason for this fault is incorrect wiring (see examples below). When touching the TEST key in all functions that requires mains supply the user automatically performs this test.

#### Examples for application of PE test terminal

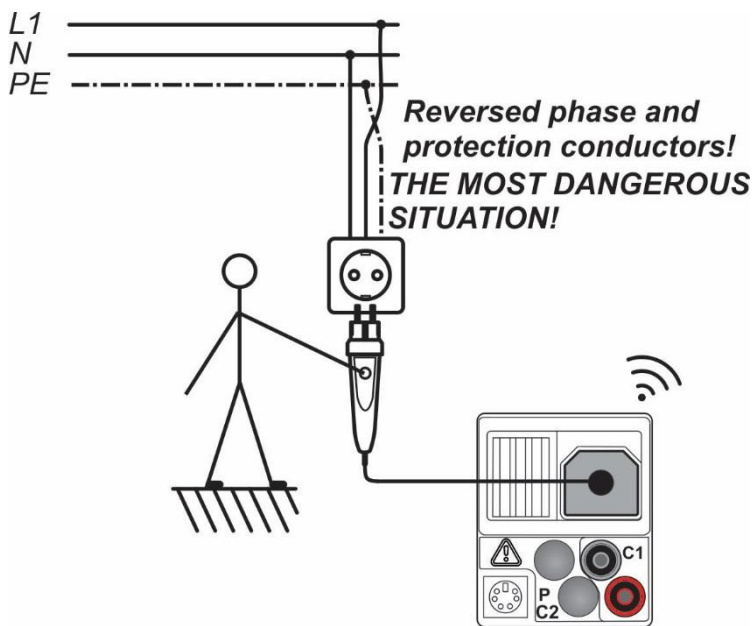

Figure 5.43: Reversed L and PE conductors (plug commander)

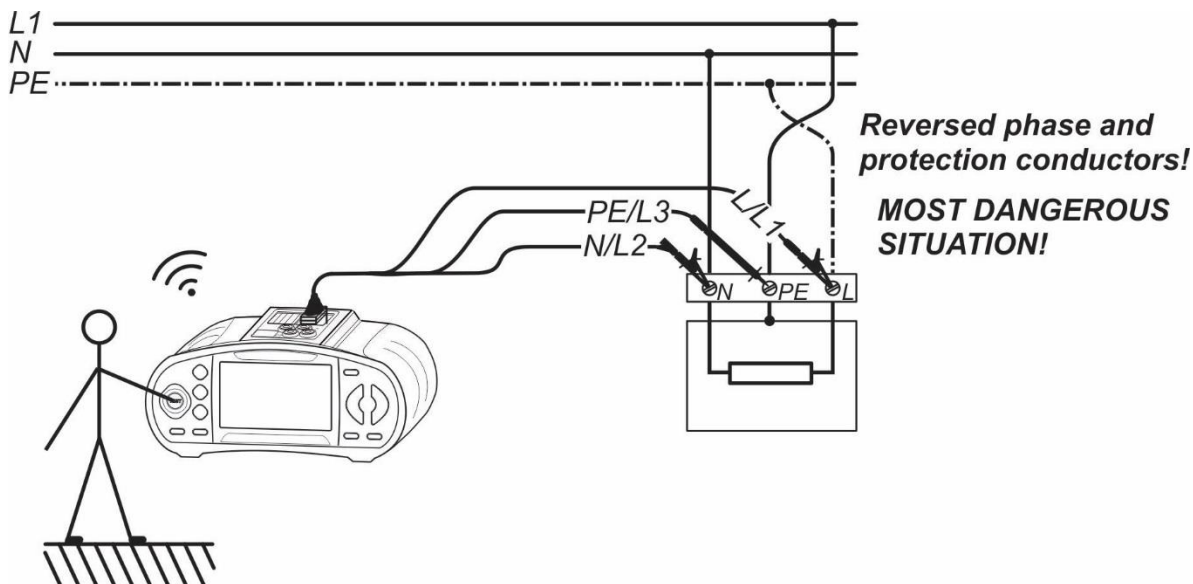

Figure 5.44: Reversed L and PE conductors (application of 3-wire test lead)

**PE terminal test procedure**

- ❑ **Connect** test cable to the instrument.
- ❑ **Connect** test leads to the item to be tested ( see *Figure 5.43* and *Figure 5.44*).
- ❑ **Touch** PE test probe (the **TEST** key) for at least one second.
- ❑ If PE terminal is connected to phase voltage the warning message is displayed, instrument buzzer is activated, and further measurements are disabled in Zloop and RCD functions.

**Warning:**

- ❑ If dangerous voltage is detected on the tested PE terminal, immediately stop all measurements, find and remove the fault!

**Notes:**

- ❑ PE test terminal is active in the INSTALLATION operating mode (except in the VOLTAGE, Low ohm, Earth and Insulation functions).
- ❑ PE test terminal does not operate in case the operator's body is completely insulated from floor or walls!
- ❑ For operation of PE test terminal on commanders refer to chapter **Appendix D – Commanders (A 1314, A 1401)**.

## 5.10 Power

The Power function is intended to measure the standard power parameters P, Q, S, THDU and PF.

See chapter **4.2 Function** selection for instructions on key functionality.

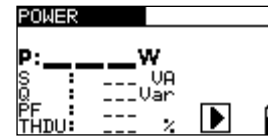

Figure 5.45: Power menu

### Settings and parameters for Power measurement

There are no parameters to be set in this menu.

### Connection for Power measurement

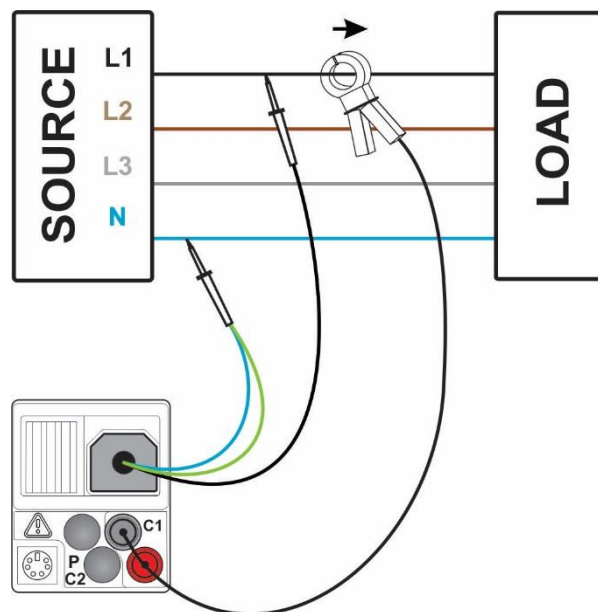

Figure 5.46: Power measurement

**Power measurement procedure**

- ❑ Select **POWER** sub-function from the **OTHERS** menu.
- ❑ **Connect** the voltage test leads and current clamp to the instrument.
- ❑ **Connect** the voltage test leads and current clamp to the item to be tested (see *Figure 5.46*).
- ❑ Press the **TEST** key to start the continuous measurement.
- ❑ Press the **TEST** key again to stop the measurement.
- ❑ **Store** the result by pressing the **MEM** key (optional).



Figure 5.47: Power measurement results

Displayed results for the Power measurement:

- P**..... active power
- S**..... apparent power
- Q** ..... reactive power (capacitive or inductive)
- PF**..... power factor (capacitive or inductive)
- THDU**..... voltage total harmonic distortion

**Notes:**

- ❑ Consider polarity and setup of current clamps (see chapter 4.4.9 *Clamp Settings*).
- ❑ Results can also be stored while the measurement is running.

## 5.11 Harmonics

Harmonics are components of the voltage and currents signal with an integer multiple of the fundamental frequency. The harmonic values are an important parameter of power quality.

See chapter **4.2 Function** selection for instructions on key functionality.



Figure 5.48: Harmonics menu

### Settings and parameters in Harmonics function

Input	Displayed parameters [ voltage U or current I]
h:0 h:11	Selected harmonic

### Connection for the Harmonics measurement

See Figure 5.46.

### Harmonics measurement procedure

- ❑ Select **HARMONICS** function from the **OTHERS** menu.
- ❑ Select test **parameters** (optional).
- ❑ **Connect** voltage test leads and current clamp to the instrument.
- ❑ **Connect** the voltage test leads and current clamp to the item to be tested (see Figure 5.46).
- ❑ Press the **TEST** key to start the continuous measurement.
- ❑ Press the **TEST** key again to stop the measurement.
- ❑ **Store** the result by pressing the **MEM** key (optional)



Figure 5.49: Examples of Harmonics measurement results

Displayed results for the Harmonics measurement:

- Uh** ..... TRMS voltage of selected harmonic
- Ih** ..... TRMS current of selected harmonic
- THDU** ..... voltage total harmonic distortion
- THDI** ..... current total harmonic distortion

### Notes:

- ❑ For setup of current clamps (see chapter 4.4.9 Clamp Settings).
- ❑ Parameters (input and number of harmonic) can be changed and results can also be stored while the measurement is running.
- ❑ Displayed graph is auto-ranged.

## 5.12 Current

This function is intended for measurement of load and leakage currents with current clamps. One measuring input is available.

See chapter 4.2 **Function** selection for instructions on key functionality.

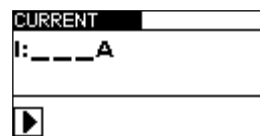

Figure 5.50: Current menu

### Connection for current measurement

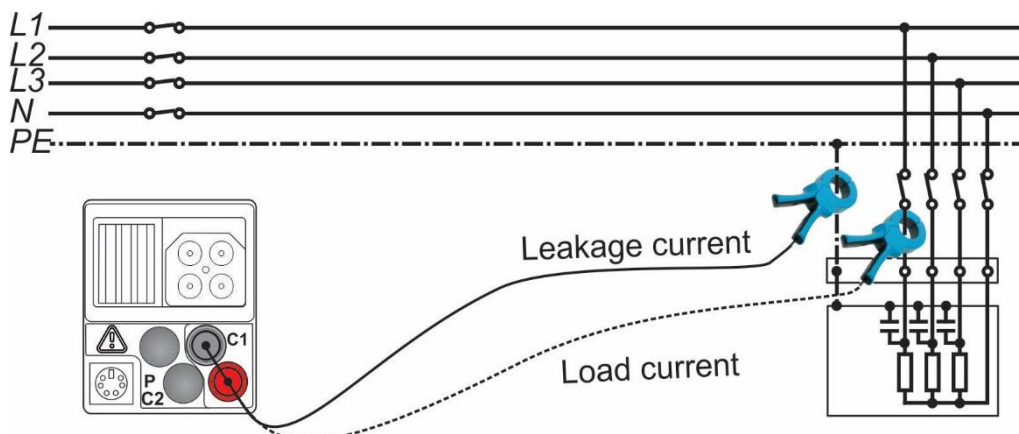

Figure 5.51: Leakage and load current measurements

### Current measurement procedure

- ❑ Select **CURRENT** function from the **OTHERS** menu.
- ❑ **Connect** current clamp to the instrument.
- ❑ **Connect** the clamp to the item to be tested (see Figure 5.51).
- ❑ Press the **TEST** key to start the continuous measurement.
- ❑ Press the **TEST** key again to stop the measurement.
- ❑ **Store** the result by pressing the **MEM** key (optional).

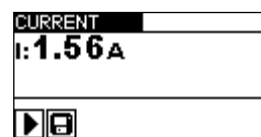
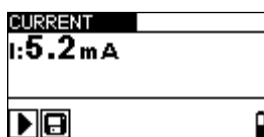

Figure 5.52: Examples of current measurement result

Displayed results for current measurement:

I..... Current

**Note:**

- ❑ For setup of current clamps see chapter 4.4.9 *Clamp Settings*.

### 5.13 First fault leakage current – ISFL (MI 3102 BT only)

First fault leakage current measurement is performed in order to verify the maximum current that could leak into PE from observed line. This current flows through the insulation resistance and reactance (capacitance) between the other lines and PE when the first fault is applied as short circuit between observed line and PE.

See chapter 4.2 **Function** selection for instructions on key functionality.

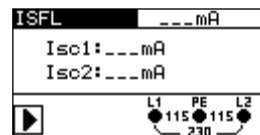

Figure 5.53: ISFL measurement

#### Test parameters for first fault leakage current measurement

Limit	Maximum leakage current [OFF, 3.0 mA ÷ 19.5 mA]
-------	---

#### Test circuit for first fault leakage current

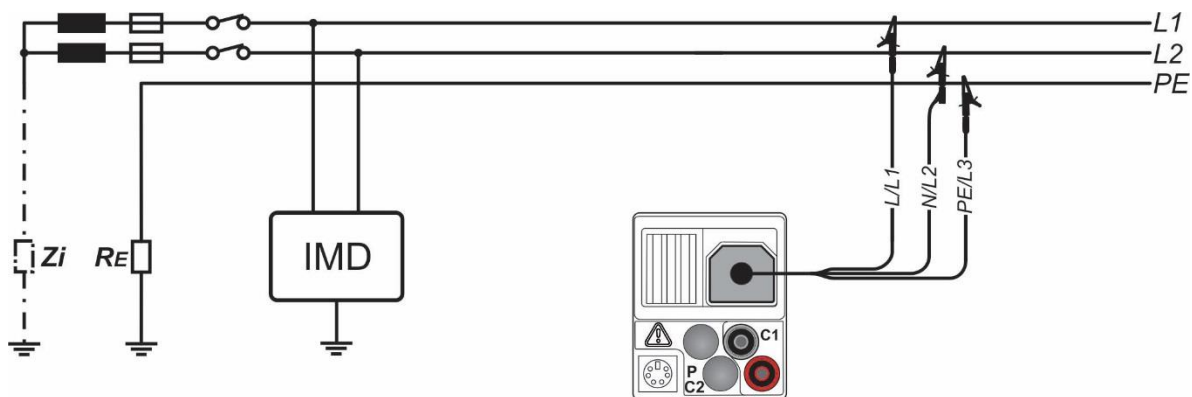

Figure 5.54: Measurement of highest first fault leakage current with 3-wire test lead

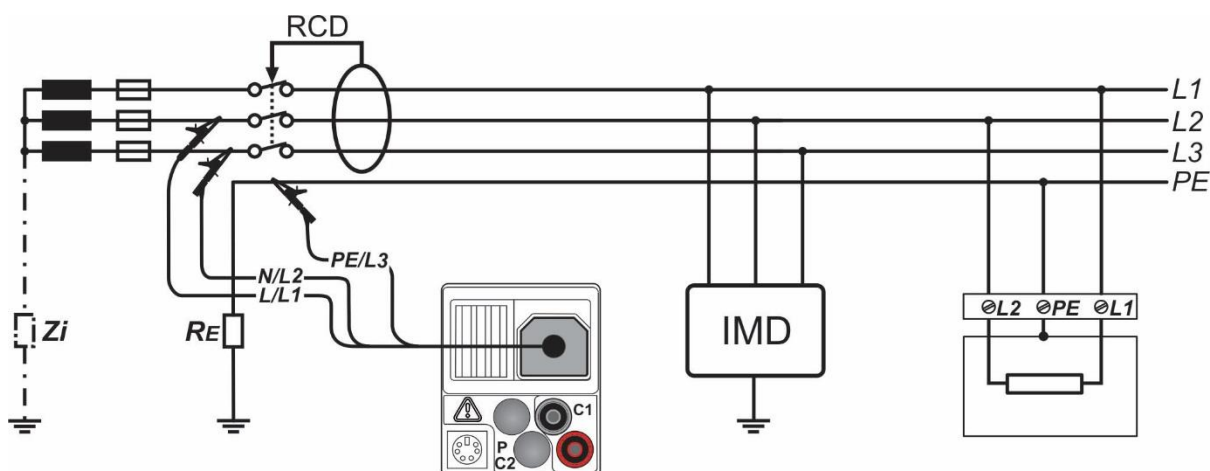

Figure 5.55: Measurement of first fault leakage current for RCD protected circuit with 3-wire test lead



**First fault leakage current measuring procedure**

- ❑ Select the **ISFL** function from the **OTHERS** menu.
- ❑ Enable and set **limit** value (optional).
- ❑ **Connect** 3-wire test lead or mains measuring cable to the instrument and tested installation (see Figure 5.54 and Figure 5.55).
- ❑ Press the **TEST** key to start measurement.
- ❑ **Store** the result by pressing the **MEM** key (optional).



Figure 5.56: Examples of measurement results for the first fault leakage current

Displayed results:

**Isc1** ..... first fault leakage current at single fault between L1/PE

**Isc2** ..... first fault leakage current at single fault between L2/PE

### 5.14 Testing of insulation monitoring devices – IMD (MI 3102 BT only)

This function is intended for checking the alarm threshold of insulation monitor devices (IMD) by applying a changeable resistance between L1/PE and L2/PE terminals.

See chapter 4.2 **Function** selection for instructions on key functionality.

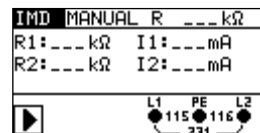

Figure 5.57: IMD test

#### Test parameters for IMD test

Type	Test mode [MANUAL R, MANUAL I, AUTO R, AUTO I]
Limit	<b>MANUAL R: Minimum insulation resistance</b> [OFF, 5 kΩ ÷ 640 kΩ]
	<b>MANUAL I: Maximum current</b> [OFF, 0.1 mA ÷ 19.9 mA]
	<b>AUTO R: Minimum insulation resistance</b> [OFF, 5 kΩ ÷ 640 kΩ], <b>Timer</b> [1 s ÷ 99 s]
	<b>AUTO I: Maximum current</b> [OFF, 0.1 mA ÷ 19.9 mA], <b>Timer</b> [1 s ÷ 99 s]

#### Test circuit for IMD test

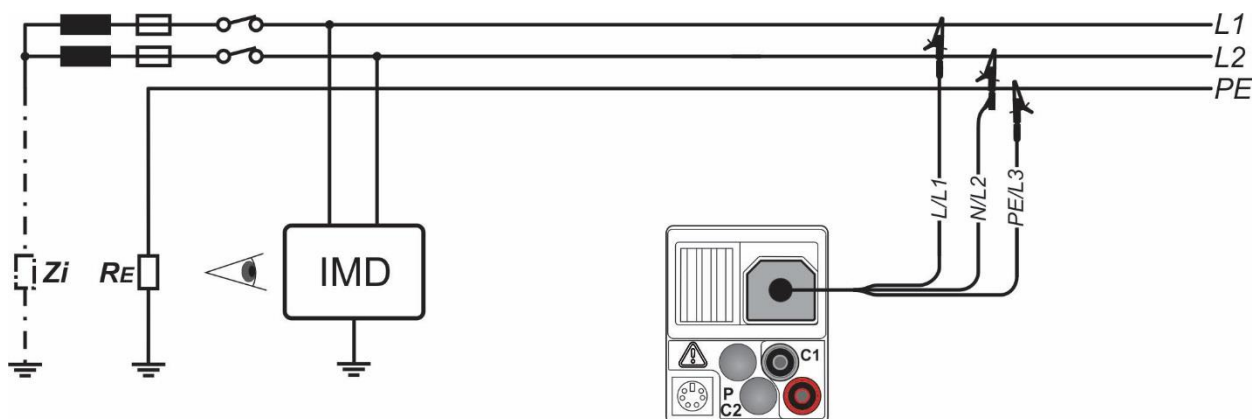

Figure 5.58: Connection with 3-wire test lead

**IMD test procedure (MANUAL R, MANUAL I)**

- ❑ Select the **IMD** function from the **OTHERS** menu.
- ❑ Select **MANUAL R** or **MANUAL I** sub-function.
- ❑ Enable and set **limit** value.
- ❑ **Connect** 3-wire test lead to the instrument and tested item (see Figure 5.58).
- ❑ Press the **TEST** key for measurement.
- ❑ Press the **UP / DOWN** keys to change insulation resistance<sup>\*)</sup> until IMD alarms an insulation failure for L1.
- ❑ Press the **TEST** key to change line terminal selection to L2.
- ❑ In case, when IMD switches off voltage supply, instruments automatically change line terminal selection to L2 and proceed with the test when instrument detects supply voltage.
- ❑ Press the **UP / DOWN** keys to change insulation resistance<sup>\*)</sup> until IMD alarms an insulation failure for L2.
- ❑ Press the **TEST** key.
- ❑ If IMD switches off voltage supply, instrument automatically proceeds to the PASS/FAIL indication.
- ❑ Use the **TAB** key to select PASS / FAIL indication.
- ❑ Press the **TEST** key to confirm selection and stop the measurement.
- ❑ **Store** the result (optional).

**IMD test procedure (AUTO R, AUTO I)**

- ❑ Select the **IMD** function from the **OTHERS** menu.
- ❑ Select **AUTO R** or **AUTO I** sub-function.
- ❑ Enable and set **limit** values.
- ❑ **Connect** 3-wire test lead to the instrument and tested item (see Figure 5.58).
- ❑ Press the **TEST** key for measurement.
- ❑ Insulation resistance between L1-PE is decreased automatically according to limit value<sup>\*)</sup> every time interval selected with timer. To speed up the test press the **UP / DOWN** keys until IMD alarms an insulation failure for L1.
- ❑ Press the **TEST** key to change line terminal selection to L2.
- ❑ In case, when IMD switches off voltage supply, instruments automatically changes line terminal selection to L2 and proceeds with the test when instrument detects supply voltage.
- ❑ Insulation resistance between L2-PE is decreased automatically according to limit value<sup>\*)</sup> every time interval selected with timer. To speed up the test press the **UP / DOWN** keys until IMD alarms an insulation failure for L2.
- ❑ Press the **TEST** key.
- ❑ If IMD switches off voltage supply, instrument automatically proceeds to the PASS/FAIL indication.
- ❑ Use the **TAB** key to select PASS / FAIL indication.
- ❑ Press the **TEST** key to confirm selection and stop the measurement.
- ❑ **Store** the result (optional).

<sup>\*)</sup> When MANUAL R or AUTO R sub-function is selected, start value of insulation resistance is determined by  $R_{start} \cong 1.5 \times R_{limit}$

When MANUAL I or AUTO I sub-function is selected, start value of insulation resistance is determined by  $R_{start} \cong 1.5 \times \frac{U_{L1-L2}}{I_{limit}}$



Figure 5.59: Examples of IMD test results

Displayed results:

- R1** ..... threshold indicative insulation resistance for L1
- R2** ..... threshold indicative insulation resistance for L2
- I1** ..... calculated first fault leakage current for R1
- I2** ..... calculated first fault leakage current for R2

Calculated first fault leakage current at threshold insulation resistance is given as:

$$I_{1(2)} = \frac{U_{L1-L2}}{R_{1(2)}}$$

$U_{L1-L2}$  is line-line voltage. The calculated first fault current is the maximum current that would flow when insulation resistance decreases to the same value as the applied test resistance, and a first fault is assumed between opposite line and PE.

## 5.15 PE conductor resistance

In TN system instrument measure the resistance of the protection conductor from the power transformer to the measurement site.

In TT system the resistance of protection conductor from mains outlet to earth electrode and back to the power transformer via soil and the transformers earthing system is measured.

See chapter **4.2 Function** selection for instructions on key functionality.

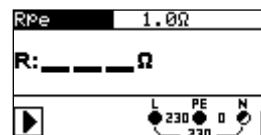

Figure 5.60: PE conductor resistance

### Test parameters for PE conductor resistance measurement

Test	Selection of PE conductor resistance sub-function [Rpe,Rpe(rcd)]
Lim	Maximum resistance [OFF, 0.1 Ω ÷ 20.0 Ω].

### Circuits for measurement of PE conductor resistance

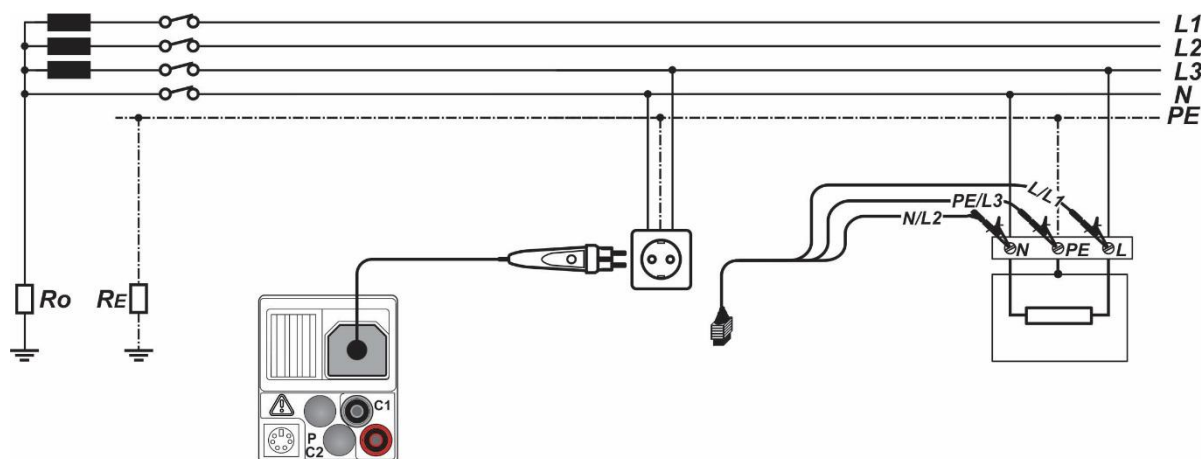

Figure 5.61: Connection of plug commander and 3-wire test lead

### PE conductor resistance measurement procedure

- ❑ Select the **Rpe** or **Rpe(rcd)** sub-function using the function selector keys and **UP / DOWN** keys.
- ❑ Select test **parameters** (optional).
- ❑ **Connect** test cable to the instrument.
- ❑ **Connect** test leads to the item to be tested (see *Figure 5.61*).
- ❑ Press the **TEST** key to perform the measurement.
- ❑ **Store** the result by pressing the **MEM** key (optional).



Figure 5.62: Examples of PE conductor resistance measurement result

Displayed results:

R ..... PE conductor resistance

**Notes:**

- ❑ High fluctuations of mains voltage can influence the measurement results (the noise sign  is displayed in the message field). In this case it is recommended to repeat few measurements to check if the readings are stable.
- ❑ This measurement will trip-out the RCD in RCD-protected electrical installation if test Rpe is selected.
- ❑ Select Rpe(rcd) measurement to prevent trip-out of RCD in RCD protected installation.

## 5.16 Illumination

The illumination measurements should be performed whenever planning or installing indoor or outdoor lighting.

Illumination measurement can be performed using LUXmeter probe connected to the PS/2 connector of the instrument. The Eurotest instrument supports LUXmeter type B and LUXmeter type C probes.

See chapter 4.2 **Function** selection for instructions on key functionality.

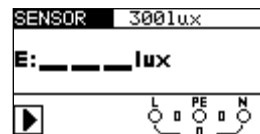

Figure 5.63: Illumination

### Test parameters for illumination measurement

<b>Lim</b>	<b>Minimum illumination</b> [OFF, 0.1 lux ÷ 20 klux].
------------	---

### Probe positioning for measurement of illumination

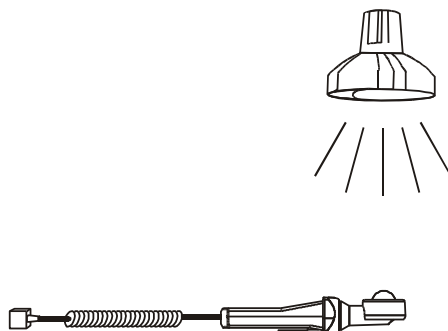

Figure 5.64: LUXmeter probe positioning

**Illumination measurement procedure**

- ❑ Select the **SENSOR** function from **OTHERS** menu.
- ❑ Select test **parameters** (optional).
- ❑ **Connect** illumination sensor to the instrument.
- ❑ Take the position of LUXmeter (see *Figure 5.64*). Make sure that LUXmeter is turned on.
- ❑ Press the **TEST** key to start the continuous measurement.
- ❑ Press the **TEST** key again to stop the measurement.
- ❑ **Store** the result by pressing the **MEM** key (optional).



Figure 5.65: Example of illumination measurement result

Displayed results:

E..... Illumination

**Notes:**

- ❑ For accurate measurement make sure that the milk glass bulb is lit without any shadows cast by hand, body or other unwanted objects.
- ❑ It is very important to know that the artificial light sources reach full power of operation after a period of time (see technical data for light sources) and should be therefore switched on for this period of time before the measurements are taken.

## 6 Auto-sequences

Auto-sequences are intended to perform automatic executing of pre-defined measurement sequences. Sequences are divided into four groups, each for selected supply system:

- ❑ AUTO TT,
- ❑ AUTO TN (RCD),
- ❑ AUTO TN and
- ❑ AUTO IT (MI 3102 BT only).

The selected sequence is carried out in one set of automatic tests, guided by the instrument.

See chapter **4.2 Function** selection for instructions on key functionality.

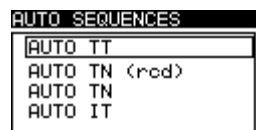

Figure 6.1: Main auto-sequence menu

### Keys in main auto-sequence menu

<b>UP / DOWN</b>	Selects auto-sequence.
<b>TEST</b>	Enters selected auto-test sequence.
<b>ESC</b>	Exits back to previous menu.

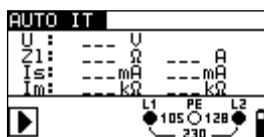
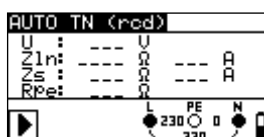
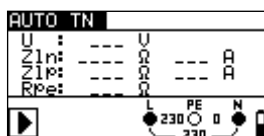
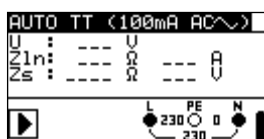

Figure 6.2: Auto-sequence menus

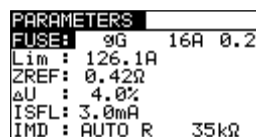
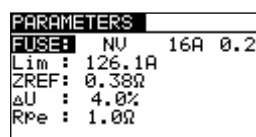
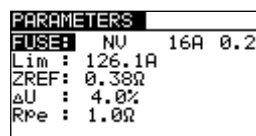
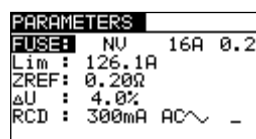

Figure 6.3: Editing parameters menus



## Keys in auto-sequence and editing parameters menu

Key	Auto-sequence menu	Editing parameters menu
<b>TAB</b>	Enters viewing/editing test parameters.	Selects the test parameter to be set or modified.
<b>UP / DOWN</b>		Sets or modifies test parameters.
<b>TEST</b>	Runs selected auto-sequence.	Runs selected auto-sequence.
<b>HELP / CAL</b> <i>Click</i>	Switch between screens.	Measuring reference line impedance (when ZREF is selected).
<b>HELP / CAL</b> <i>Keep pressed for 1 s</i>	Enters help screens.	Enters help screens.
<b>MEM</b>	Stores auto-test results.	
<b>ESC</b>	Exits back to previous menu.	Exits back to previous menu with saving changes.

The following tests / measurements can be performed for selected autosequence. Parameters in each auto-sequence are user-defined as follows.

Auto-sequence	Test measurement /	Available editable parameters	
<b>AUTO TT</b>	VOLTAGE Z LINE $\Delta U^*$ Zs rcd Uc	FUSE	fuse type, rated current, maximal braking time, minimal short-circuit current
		ZREF	reference line impedance
		$\Delta U$	voltage drop limit value
		RCD	nominal current, RCD type, maximal contact voltage
<b>AUTO TN (RCD)</b>	VOLTAGE Z LINE $\Delta U^*$ Zs rcd Rpe(rcd)	FUSE	fuse type, rated current, maximal braking time, minimal short-circuit current
		ZREF	reference line impedance
		$\Delta U$	voltage drop limit value
		RPE	maximal PE line resistance
<b>AUTO TN</b>	VOLTAGE Z LINE $\Delta U^*$ Z LOOP Rpe	FUSE	fuse type, rated current, maximal braking time, minimal short-circuit current
		ZREF	reference line impedance
		$\Delta U$	voltage drop limit value
		RPE	maximal PE line resistance
<b>AUTO IT</b>	VOLTAGE Z LINE $\Delta U^*$ ISFL IMD	FUSE	fuse type, rated current, maximal braking time, minimal short-circuit current
		ZREF	reference line impedance
		$\Delta U$	voltage drop limit value
		ISFL	maximal leakage current
		IMD	test type, minimal insulation or maximal leakage current

\* applicable only if  $Z_{REF}$  is set

**Circuit for automatic measurement**

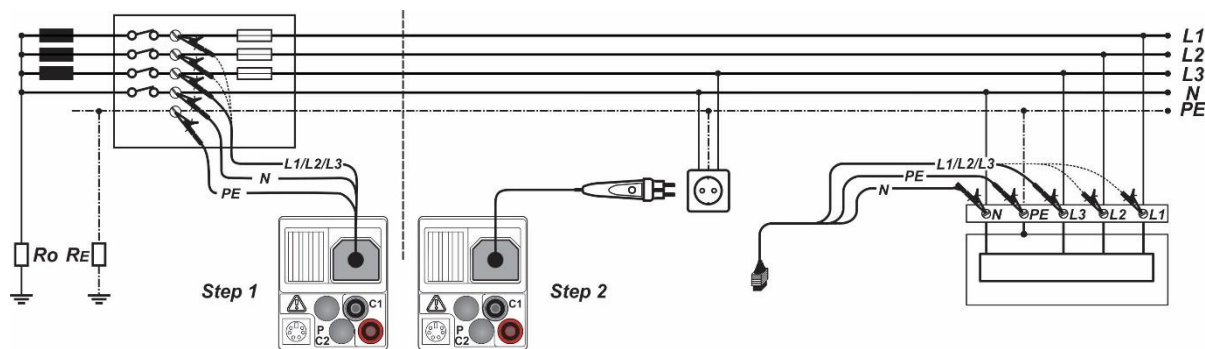

Figure 6.4: Auto-sequence setup

**Automatic measurement procedure**

- ❑ Enter **AUTO SEQUENCES** mode from main menu.
- ❑ Select auto-sequence **AUTO TT**, **AUTO TN (rcd)**, **AUTO TN**, or **AUTO IT**.
- ❑ Select test **parameters**.
- ❑ **Connect** test cable to the instrument.
- ❑ **Connect** the test leads to the origin of electrical installation (see Figure 6.4 – step 1) (optional).
- ❑ Press the **CAL** key to perform the  $Z_{REF}$  measurement (optional).
- ❑ **Connect** test leads to the item to be tested (see Figure 6.4 – step 2).
- ❑ Press the **TEST** key to start the auto-sequence.
- ❑ **Store** the result by pressing the **MEM** key (optional).

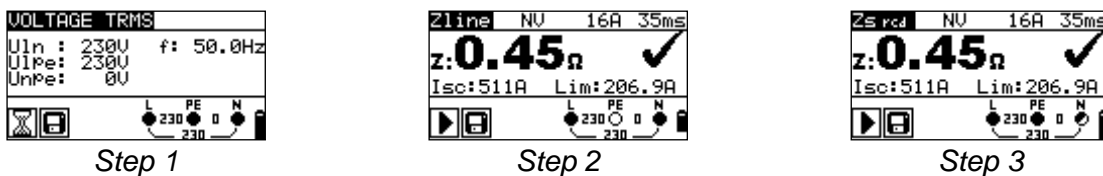

Figure 6.5: Individual steps of AUTO TT auto-sequence

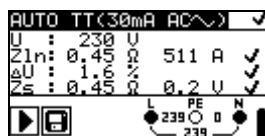

Figure 6.6: Example of AUTO TT auto-sequence results

**Displayed results during auto-sequence and saved results**

**Voltage**

Displayed results for single phase system:

- Uln** ..... voltage between phase and neutral conductors
- Ulpe** ..... voltage between phase and protective conductors
- Unpe** ..... voltage between neutral and protective conductors
- f** ..... frequency

Displayed results for IT system:

**U12**..... voltage between phases L1 and L2  
**U1pe** ..... voltage between phase L1 and protective conductor  
**U2pe** ..... voltage between phase L2 and protective conductor  
**f**..... frequency

#### Line impedance

**Z**..... line impedance  
**Isc** ..... prospective short-circuit current  
**Lim**..... low limit prospective short-circuit current value

#### Loop impedance (Zs or Zs<sub>RCD</sub>)

**Z**..... loop impedance  
**Isc** ..... prospective fault current  
**Lim**..... low limit prospective fault current value

#### PE conductor resistance (Rpe or Rpe<sub>RCD</sub>)

**R** ..... PE conductor resistance

#### First fault leakage current - ISFL (AUTO IT sequence only)

**Isc1** ..... first fault leakage current at single fault between L1/PE  
**Isc2** ..... first fault leakage current at single fault between L2/PE

#### Testing of insulation monitoring devices - IMD (AUTO IT sequence only)

**R1** ..... threshold indicative insulation resistance for phase 1  
**I1** ..... first fault leakage current at single fault between L1/PE  
**R2** ..... threshold indicative insulation resistance for phase 2  
**I2** ..... first fault leakage current at single fault between L2/PE

#### Displayed results once auto-sequence finished and recalled results:

AUTO TN				✓
Z <sub>ln</sub> :	0.46 Ω	495 A		✓
ΔU:	0.1 %			✓
Z <sub>lp</sub> :	0.49 Ω	468 A		✓
R <sub>pe</sub> :	0.00 Ω			✓
				>5/5
				MEM

Figure 6.7: Example of recalled AUTO TN auto-sequence results

Function	Results field	
	Left value on display	Right value on display
U	<b>Voltage</b>	
	Voltage between phase and neutral. Voltage between phases L1 and L2 (IT system)	
ZIn	<b>Line impedance</b>	
	Line impedance	Prospective short-circuit current
$\Delta U^*$	<b>Voltage drop</b>	
	Voltage drop (if available)	
Zs	<b>Loop impedance</b>	
	Loop impedance	Contact voltage (AUTO TT only) or Prospective fault current (AUTO TT excepted)
ZIp	<b>Loop impedance</b>	
	Loop impedance	Prospective short-circuit current
Rpe	<b>PE conductor resistance</b>	
	PE conductor resistance	
Is	<b>First fault leakage current</b>	
	First fault leakage current at single fault between L1/PE	First fault leakage current at single fault between L2/PE
Im	<b>Testing of insulation monitoring devices</b>	
	Threshold indicative insulation resistance for phase 1	Threshold indicative insulation resistance for phase 2

**Notes:**

- Before starting the auto-sequence, all settings of parameters should be checked.
- $\Delta U$  measurement in each auto-sequence is enabled only if  $Z_{REF}$  is set.

# 7 Data handling

## 7.1 Memory organization

Measurement results together with all relevant parameters can be stored in the instrument's memory. After the measurement is completed, results can be stored to the flash memory of the instrument, together with the sub-results and function parameters.

## 7.2 Data structures

The instrument's memory place is divided into two 4 level data structures. The number of measurements that can be stored into one location is not limited.

The **data structure fields** describe the location of the measurement (which object, block, fuse, connection or which EVSE, sublevel).

In the **measurement field** there is information about type and number of measurements that belong to the selected structure element (object, block, fuse, connection, EVSE, level).

The main advantages of this system are:

- ❑ Test results can be organized and grouped in a structured manner that reflects the structure of typical electrical installations and EVSEs.
- ❑ Customized names of data structure elements can be uploaded from EurolinkPRO PCSW.
- ❑ Simple browsing through structure and results.
- ❑ Test reports can be created with no or little modifications after downloading results to a PC.

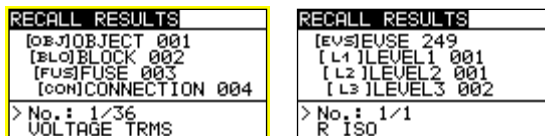

Figure 7.1: Object and EVSE data structure fields

**Note:**

- ❑ The descriptions in this Instruction manual mainly refer to an Object data structure. Operation is the same if working with an EVSE data structure.

**Data structure field**

RECALL RESULTS	Memory operation menu
[OBJ]OBJECT 001 [BLK]BLOCK 002 [FUS]FUSE 003 [CON]CONNECTION 004	Data structure field
[OBJ]OBJECT 001	<b>1<sup>st</sup> level:</b> <b>OBJECT:</b> Default location name (object and its successive number). <b>001:</b> No. of selected element.
[BLK]BLOCK 002	<b>2<sup>nd</sup> level:</b> <b>BLOCK:</b> Default location name (block and its successive number). <b>002:</b> No. of selected element.
[FUS]FUSE 003	<b>3<sup>rd</sup> level:</b>

	<b>FUSE:</b> Default location name (fuse and its successive number). <b>003:</b> No. of selected element.
[com]CONNECTION 004	<b>4<sup>th</sup> level:</b> <b>CONNECTION:</b> Default location name (connection and its successive number). <b>004:</b> No. of selected element.
No.: 20 [132]	No. of measurements in selected location [No. of measurements in selected location and its sub-locations]

**Measurement field**

VOLTAGE TRMS	Type of stored measurement in the selected location.
No.: 1/36	No. of selected test result / No. of all stored test results in selected location.

### 7.3 Storing test results

After the completion of a test the results and parameters are ready for storing (  icon is displayed in the information field). By pressing the **MEM key**, the user can store the results.

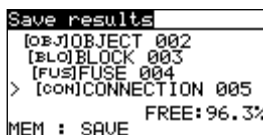

Figure 7.2: Save test menu

FREE: 96.3% Memory available for storing results.

**Keys in save test menu - data structure field**

<b>TAB</b>	Selects the location element (Object / Block / Fuse / Connection)
<b>UP / DOWN</b>	Selects number of selected location element (1 to 199)
<b>MEM</b>	Saves test results to the selected location and returns to the measuring function.
<b>ESC / TEST / Function selector</b>	Exits back to measuring function without saving.

**Notes:**

- ❑ The instrument offers to store the result to the last selected location by default.
- ❑ If the measurement is to be stored to the same location as the previous one just press the MEM key twice.

## 7.4 Recalling test results

Press the **MEM** key in a main function menu when there is no result available for storing or select MEMORY in the **SETTINGS** menu.

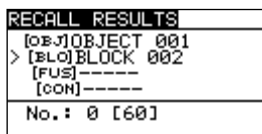

Figure 7.3: Recall menu - installation structure field selected

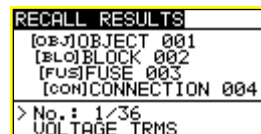

Figure 7.4: Recall menu - measurements field selected

### Keys in recall memory menu (installation structure field selected):

<b>TAB</b>	Selects the location element (Object / Block / Fuse / Connection).
<b>UP / DOWN</b>	Selects number of selected location element (1 to 199).
<b>Function selector / ESC</b>	Exits back to main function menu.
<b>TEST / MEM</b>	Enters measurements field.

### Keys in recall memory menu (measurements field selected):

<b>UP / DOWN</b>	Selects the stored measurement.
<b>TAB / ESC</b>	Returns to installation structure field.
<b>Function selector</b>	Exits back to main function menu.
<b>TEST / MEM</b>	View selected measurement results.

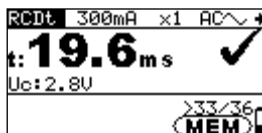

Figure 7.5: Example of recalled measurement result

### Keys in recall memory menu (measurement results are displayed)

<b>UP / DOWN</b>	Displays measurement results stored in selected location.
<b>MEM / ESC</b>	Returns to measurements field.
<b>TEST</b>	Returns to installation structure field.
<b>Function selector</b>	Exits back to main function menu.

## 7.5 Clearing stored data

### 7.5.1 Clearing complete memory content

Select **CLEAR ALL MEMORY** in **MEMORY** menu. A warning will be displayed.

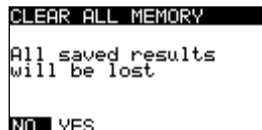

Figure 7.6: Clear all memory

#### Keys in clear all memory menu

<b>TEST</b>	Confirms clearing of complete memory content ( <b>YES</b> must be selected with <b>UP / DOWN</b> keys).
<b>ESC</b>	Exits back to memory menu without changes.
<b>Function selector</b>	Exits back to main function menu without changes.

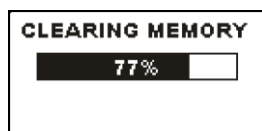

Figure 7.7: Clearing memory in progress

### 7.5.2 Clearing measurement(s) in selected location

Select **DELETE RESULTS** in **MEMORY** menu.

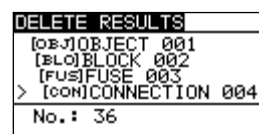
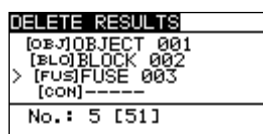

Figure 7.8: Clear measurements menu (data structure field selected)

#### Keys in delete results menu (installation structure field selected):

<b>TAB</b>	Selects the location element (Object / Block / Fuse / Connection).
<b>UP / DOWN</b>	Selects number of selected location element (1 to 199)
<b>Function selector</b>	Exits back to main function menu.
<b>ESC</b>	Exits back to memory menu.
<b>TEST</b>	Enters dialog box for deleting all measurements in selected location and its sub-locations.

#### Keys in dialog for confirmation to clear results in selected location:

<b>TEST</b>	Deletes all results in selected location.
<b>MEM / ESC</b>	Exits back to delete results menu without changes.
<b>Function selector</b>	Exits back to main function menu without changes.



### 7.5.3 Clearing individual measurements

Select **DELETE RESULTS** in **MEMORY** menu.

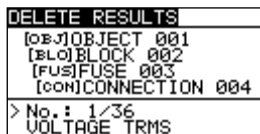

Figure 7.9: Menu for clearing individual measurement (installation structure field selected)

#### Keys in delete results menu (installation structure field selected):

<b>TAB</b>	Selects the location element (Object / Block / Fuse / Connection).
<b>UP / DOWN</b>	Selects number of selected location element (1 to 199)
<b>Function selector</b>	Exits back to main function menu.
<b>ESC</b>	Exits back to memory menu.
<b>MEM</b>	Enters measurements field for deleting individual measurements.

#### Keys in delete results menu (measurements field selected):

<b>UP / DOWN</b>	Selects measurement.
<b>TEST</b>	Opens dialog box for confirmation to clear selected measurement.
<b>TAB / ESC</b>	Returns to installation structure field.
<b>Function selector</b>	Exits back to main function menu without changes.

#### Keys in dialog for confirmation to clear selected result(s):

<b>TEST</b>	Deletes selected measurement result.
<b>MEM / TAB / ESC</b>	Exits back to measurements field without changes.
<b>Function selector</b>	Exits back to main function menu without changes.



Figure 7.10: Dialog for confirmation

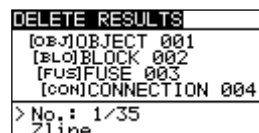

Figure 7.11: Display after measurement was cleared

### 7.5.4 Renaming installation structure elements (upload from PC)

Default installation structure elements are »Object«, »Block«, »Fuse« and »Connection«. In the PCSW package Eurolink-PRO default names can be changed with customized names that corresponds the installation under test. Refer to PCSW Eurolink-PRO HELP for information how to upload customized installation names to the instrument.

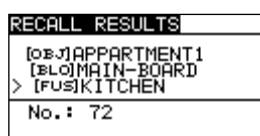

Figure 7.12: Example of menu with customized installation structure names

### 7.5.5 Renaming installation structure elements with serial barcode reader or RFID reader

Default installation structure elements are »Object«, »Block«, »Fuse« and »Connection«.  
When the instrument is in the SAVERESULTS menu location ID can be scanned from a barcode label with the barcode reader or can be read from a RFID tag with the RFID reader.

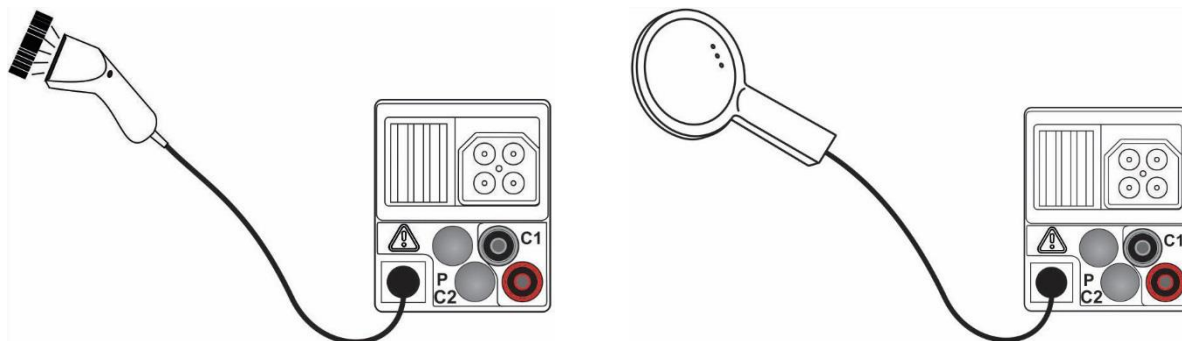

Figure 7.13: Connection of the barcode reader and RFID reader

#### How to change the name of memory location

- ❑ Connect the barcode reader or RFID reader to the instrument.
- ❑ In Save menu select memory location to be renamed.
- ❑ A new location name (scanned from a barcode label or a RFID tag) will be accepted by the instrument. A successful receive of the barcode or RFID tag is confirmed by two short confirmation beeps.

#### Note:

- ❑ Use only barcode readers and RFID readers delivered by METREL or authorized distributor.

## 7.6 Communication

Stored results can be transferred to a PC. A special communication program on the PC automatically identifies the instrument and enables data transfer between the instrument and the PC.

There are three communication interfaces available on the instrument: USB, RS 232 and Bluetooth.

### 7.6.1 USB and RS232 communication

The instrument automatically selects the communication mode according to detected interface. USB interface has priority.

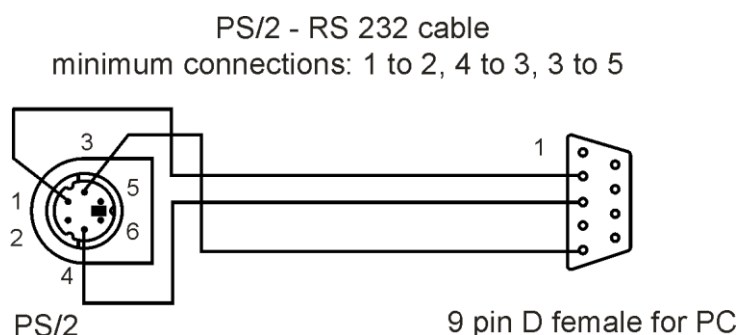

Figure 7.14: Interface connection for data transfer over PC COM port

#### How to establish an USB or RS-232 link:

- ❑ RS-232 communication: connect a PC COM port to the instrument PS/2 connector using the PS/2 - RS232 serial communication cable;
- ❑ USB communication: connect a PC USB port to the instrument USB connector using the USB interface cable.
- ❑ Switch on the PC and the instrument.
- ❑ Run the EuroLinkPRO program.
- ❑ The PC and the instrument will automatically recognize each other.
- ❑ The instrument is prepared to communicate with the PC.

The program EuroLinkPRO is a PC software running on Windows XP, Windows Vista, Windows 7, and Windows 8. Read the file README\_EuroLink.txt on CD for instructions about installing and running the program.

#### Note:

- ❑ USB drivers should be installed on PC before using the USB interface. Refer to USB installation instructions available on installation CD.

## 7.6.2 Bluetooth communication

The internal Bluetooth module enables easy communication via Bluetooth with PC and Android devices.

### **How to configure a Bluetooth link between instrument and PC**

- ❑ Switch On the instrument.
- ❑ On PC configure a Standard Serial Port to enable communication over Bluetooth link between instrument and PC. Usually no code for pairing the devices is needed.
- ❑ Run the *EuroLinkPRO* program.
- ❑ The PC and the instrument will automatically recognize each other.
- ❑ The instrument is prepared to communicate with the PC.

### **How to configure a Bluetooth link between instrument and Android device**

- ❑ Switch On the instrument.
- ❑ Some Android applications automatically carry out the setup of a Bluetooth connection. It is preferred to use this option if it exists.  
This option is supported by Metrel's Android applications.
- ❑ If this option is not supported by the selected Android application then configure a Bluetooth link via Android device's Bluetooth configuration tool. Usually no code for pairing the devices is needed.
- ❑ The instrument and Android device are ready to communicate.

#### **Notes:**

- ❑ Sometimes there will be a demand from the PC or Android device to enter the code. Enter code 'NNNN' to correctly configure the Bluetooth link.
- ❑ The name of correctly configured Bluetooth device must consist of the instrument type plus serial number, eg. *MI 3102BT-12240429I*. If the Bluetooth module got another name, the configuration must be repeated.
- ❑ In case of serious troubles with the Bluetooth communication it is possible to reinitialize the internal Bluetooth module. The initialization is carried out during the Initial settings procedure. In case of a successful initialization "INTERNAL BLUETOOTH SEARCHING OK!" is displayed at the end of the procedure. See chapter 4.4.8 *Initial settings*.

## 8 Upgrading the instrument

The instrument can be upgraded from a PC via the RS232 communication port. This enables to keep the instrument up to date even if the standards or regulations change. The upgrade can be carried with a help of special upgrading software and the communication cable as shown on *Figure 7.14*. Please contact your dealer for more information.

## 9 Maintenance

Unauthorized persons are not allowed to open the Eurotest instrument. There are no user replaceable components inside the instrument, except the battery and fuses under rear cover.

### 9.1 Fuse replacement

There are three fuses under back cover of the Eurotest instrument.

- **F1**  
M 0.315 A / 250 V, 20×5 mm  
This fuse protects internal circuitry for continuity functions if test probes are connected to the mains supply voltage by mistake during measurement.
- **F2, F3**  
F 4 A / 500 V, 32×6.3 mm (breaking capacity: 50 kA)  
General input protection fuses of test terminals L/L1 and N/L2.

Position of fuses can be seen on *Figure 3.4: Battery and fuse compartment* in chapter 3.3. *Back side*.

#### Warnings:

- Disconnect all measuring accessory and switch off the instrument before opening battery / fuse compartment cover, hazardous voltage inside!
- Replace blown fuse with original type only, otherwise the instrument or accessory may be damaged and/or operator's safety impaired!

### 9.2 Cleaning

No special maintenance is required for the housing. To clean the surface of the instrument or accessory use a soft cloth slightly moistened with soapy water or alcohol. Then leave the instrument or accessory to dry totally before use.

#### Warnings:

- Do not use liquids based on petrol or hydrocarbons!
- Do not spill cleaning liquid over the instrument!

### 9.3 Periodic calibration

It is essential that the test instrument is regularly calibrated in order that the technical specification listed in this manual is guaranteed. We recommend an annual calibration. Only an authorized technical person can do the calibration. Please contact your dealer for further information.

### 9.4 Service

For repairs under warranty, or at any other time, please contact your distributor.

## 10 Technical specifications

### 10.1 Insulation resistance

#### Insulation resistance (nominal voltages 50 V<sub>DC</sub>, 100 V<sub>DC</sub> and 250 V<sub>DC</sub>)

Measuring range according to EN 61557 is 0.15 MΩ ÷ 199.9 MΩ.

Measuring range (MΩ)	Resolution (MΩ)	Accuracy
0.00 ÷ 19.99	0.01	±(5 % of reading + 3 digits)
20.0 ÷ 99.9	0.1	±(10 % of reading)
100.0 ÷ 199.9		±(20 % of reading)

#### Insulation resistance (nominal voltages 500 V<sub>DC</sub> and 1000 V<sub>DC</sub>)

Measuring range according to EN 61557 is 0.15 MΩ ÷ 999 MΩ.

Measuring range (MΩ)	Resolution (MΩ)	Accuracy
0.00 ÷ 19.99	0.01	±(5 % of reading + 3 digits)
20.0 ÷ 199.9	0.1	±(5 % of reading)
200 ÷ 999	1	±(10 % of reading)

#### Insulation resistance (nominal voltage 2500V<sub>DC</sub>, MI 3102H BT only)

Measuring range (Ω)	Resolution (Ω)	Accuracy
0.00 MΩ ÷ 19.99 MΩ	0.01 MΩ	±(5 % of reading + 3 digits)
20.0 MΩ ÷ 199.9 MΩ	0.1 MΩ	±(5 % of reading)
200 MΩ ÷ 999 MΩ	1 MΩ	±(10 % of reading)
1.00 GΩ ÷ 19.99 GΩ	0.01 GΩ	±(10 % of reading)

#### Voltage

Measuring range (V)	Resolution (V)	Accuracy
0 ÷ 3000	1	±(3 % of reading + 3 digits)

Nominal voltages ..... 50 V<sub>DC</sub>, 100 V<sub>DC</sub>, 250 V<sub>DC</sub>, 500 V<sub>DC</sub>, 1000 V<sub>DC</sub>, 2500 V<sub>DC</sub> (MI3102HBT only)

Open circuit voltage ..... -0 % / +20 % of nominal voltage

Measuring current ..... min. 1 mA at R<sub>N</sub>=U<sub>N</sub>×1 kΩ/V

Short circuit current ..... max. 3 mA

The number of possible tests ..... > 1200, with a fully charged battery

Auto discharge after test.

Specified accuracy is valid if 3-wire test lead is used while it is valid up to 100 MΩ if tip commander is used.

Specified accuracy is valid up to 100 MΩ if relative humidity > 85 %.

In case the instrument gets moistened, the results could be impaired. In such case, it is recommended to dry the instrument and accessories for at least 24 hours.

The error in operating conditions could be at most the error for reference conditions (specified in the manual for each function) ±5 % of measured value.

## 10.2 Diagnostic test (MI 3102H BT only)

### Dielectric absorption ratio DAR\*

Measuring range	Resolution	Accuracy
0.01 ÷ 9.99	0.01	±(5% of reading + 2digits)
10.0 ÷ 100.0	0.1	±(5% of reading)

\* Only for test voltages 500 V<sub>DC</sub>, 1000 V<sub>DC</sub> and 2500V<sub>DC</sub>. If any insulation resistance values ( $R_{ISO}(15s)$  or  $R_{ISO}(60s)$ ) are over-ranged the **DAR** factor is not calculated. The result field is blank: DAR:\_\_\_\_\_!

### Polarization index PI\*\*

Measuring range	Resolution	Accuracy
0.01 ÷ 9.99	0.01	±(5% of reading + 2digits)
10.0 ÷ 100.0	0.1	±(5% of reading)

\*\* Only for test voltages 500 V<sub>DC</sub>, 1000 V<sub>DC</sub> and 2500V<sub>DC</sub>. If any insulation resistance values ( $R_{ISO}(60s)$  or  $R_{ISO}(10min)$ ) are over-ranged the **PI** factor is not calculated. The result field is blank: PI :\_\_\_\_\_!

## 10.3 Continuity

### 10.3.1 Resistance R LOW

Measuring range according to EN 61557 is 0.16 Ω ÷ 1999 Ω.

Measuring range R (Ω)	Resolution (Ω)	Accuracy
0.00 ÷ 19.99	0.01	±(3 % of reading + 3 digits)
20.0 ÷ 199.9	0.1	±(5 % of reading)
200 ÷ 1999	1	

Measuring range R+, R- (Ω)	Resolution (Ω)	Accuracy
0.0 ÷ 199.9	0.1	±(5 % of reading + 5 digits)
200 ÷ 1999	1	

Open-circuit voltage.....6.5 VDC ÷ 9 VDC

Measuring current.....min. 200 mA into load resistance of 2 Ω

Test lead compensation.....up to 5 Ω

The number of possible tests.....> 2000, with a fully charged battery

Automatic polarity reversal of the test voltage.

### 10.3.2 Resistance CONTINUITY

Measuring range (Ω)	Resolution (Ω)	Accuracy
0.0 ÷ 19.9	0.1	±(5 % of reading + 3 digits)
20 ÷ 1999	1	

Open-circuit voltage.....6.5 VDC ÷ 9 VDC

Short-circuit current .....max. 8.5 mA

Test lead compensation.....up to 5 Ω



## 10.4 RCD testing

### 10.4.1 General data

Nominal residual current (A, AC) .....	10 mA, 30 mA, 100 mA, 300 mA, 500 mA, 1000 mA
Nominal residual current (EV, MI) .....	30 mA a.c., 6 mA d.c.
Nominal residual current accuracy .....	-0 / +0.1·I $\Delta$ ; I $\Delta$ = I $\Delta$ N, 2×I $\Delta$ N, 5×I $\Delta$ N -0.1·I $\Delta$ / +0; I $\Delta$ = 0.5×I $\Delta$ N AS/NZS selected: $\pm$ 5 %
Test current shape .....	Sine-wave (AC), pulsed (A, F), smooth DC (B, B+)
DC offset for pulsed test current .....	< 2 mA (typical)
RCD type .....	(non-delayed), S (time-delayed), PRCD, PRCD-K, PRCD-S, EV RCD, MI RCD
Test current starting polarity .....	0° or 180°
Voltage range .....	93 V $\div$ 134 V (45 Hz $\div$ 65 Hz) 185 V $\div$ 266 V (45 Hz $\div$ 65 Hz)

I $\Delta$ N (mA)	I $\Delta$ N × 1/2 (mA)			I $\Delta$ N × 1 (mA)			I $\Delta$ N × 2 (mA)			I $\Delta$ N × 5 (mA)			RCD I $\Delta$		
	AC	A, F	B, B+	AC	A, F	B, B+	AC	A, F	B, B+	AC	A, F	B, B+	AC	A, F	B, B+
10	5	3.5	5	10	20	20	20	40	40	50	100	100	✓	✓	✓
30	15	10.5	15	30	42	60	60	84	120	150	212	300	✓	✓	✓
100	50	35	50	100	141	200	200	282	400	500	707	1000	✓	✓	✓
300	150	105	150	300	424	600	600	848	x	1500	x	x	✓	✓	✓
500	250	175	250	500	707	1000	1000	1410	x	2500	x	x	✓	✓	✓
1000	500	350	500	1000	1410	x	2000	x	x	x	x	x	✓	✓	x

x .....not applicable

✓ .....applicable

AC type.....sine wave test current

A, F types.....pulsed current

B, B+ types.....smooth DC current (MI 3102 BT only)

I $\Delta$ N (mA)	I $\Delta$ N × 1/2 (mA)	I $\Delta$ N × 1 (mA)	I $\Delta$ N × 2 (mA)	I $\Delta$ N × 5 (mA)	RCD I $\Delta$	
	EV / MI a.c.	EV / MI a.c.	EV / MI a.c.	EV / MI a.c.	EV / MI a.c.	EV / MI d.c.
30 a.c.	15	30	60	150	✓	x
6 d.c.	x	x	x	x	x	✓

x .....not applicable

✓ .....applicable

EV, MI type (a.c. part). .....sine wave test current

EV, MI type (d.c. part).....smooth DC current

### 10.4.2 Contact voltage RCD Uc

Measuring range according to EN 61557 is 20.0 V ÷ 31.0V for limit contact voltage 25V

Measuring range according to EN 61557 is 20.0 V ÷ 62.0V for limit contact voltage 50V

Measuring range (V)	Resolution (V)	Accuracy
0.0 ÷ 19.9	0.1	(-0 % / +15 %) of reading ± 10 digits
20.0 ÷ 99.9	0.1	(-0 % / +15 %) of reading

The accuracy is valid if mains voltage is stable during the measurement and PE terminal is free of interfering voltages.

Test current ..... max.  $0.5 \times I_{\Delta N}$

Limit contact voltage ..... 25 V, 50 V

Specified accuracy is valid for complete operating range.

### 10.4.3 Trip-out time

Complete measurement range corresponds to EN 61557 requirements.

Maximum measuring times set according to selected reference for RCD testing.

Measuring range (ms)	Resolution (ms)	Accuracy
0.0 ÷ 40.0	0.1	±1 ms
0.0 ÷ max. time *	0.1	±3 ms

\* For max. time see normative references in chapter 4.4.5 RCD testing. This specification applies to max. time >40 ms.

Test current .....  $\frac{1}{2} \times I_{\Delta N}$ ,  $I_{\Delta N}$ ,  $2 \times I_{\Delta N}$ ,  $5 \times I_{\Delta N}$

$5 \times I_{\Delta N}$  is not available for  $I_{\Delta N}=1000$  mA (RCD type AC) or  $I_{\Delta N} \geq 300$  mA (RCD types A, F).

$2 \times I_{\Delta N}$  is not available for  $I_{\Delta N}=1000$  mA (RCD types A, F).

Specified accuracy is valid for complete operating range.

### 10.4.4 Trip-out current

#### Trip-out current

Complete measurement range corresponds to EN 61557 requirements.

Measuring range $I_{\Delta}$	Resolution $I_{\Delta}$	Accuracy
$0.2 \times I_{\Delta N} \div 1.1 \times I_{\Delta N}$ (AC, EV and MI a.c. type)	$0.05 \times I_{\Delta N}$	$\pm 0.1 \times I_{\Delta N}$
$0.2 \times I_{\Delta N} \div 1.5 \times I_{\Delta N}$ (A type, $I_{\Delta N} \geq 30$ mA)	$0.05 \times I_{\Delta N}$	$\pm 0.1 \times I_{\Delta N}$
$0.2 \times I_{\Delta N} \div 2.2 \times I_{\Delta N}$ (A type, $I_{\Delta N} < 30$ mA)	$0.05 \times I_{\Delta N}$	$\pm 0.1 \times I_{\Delta N}$
$0.2 \times I_{\Delta N} \div 2.2 \times I_{\Delta N}$ (B, EV and MI d.c. type)	$0.05 \times I_{\Delta N}$	$\pm 0.1 \times I_{\Delta N}$

#### Trip-out time

Measuring range (ms)	Resolution (ms)	Accuracy
0 ÷ 300	1	±3 ms

#### Contact voltage

Measuring range (V)	Resolution (V)	Accuracy
0.0 ÷ 19.9	0.1	(-0 % / +15 %) of reading ± 10 digits
20.0 ÷ 99.9	0.1	(-0 % / +15 %) of reading

The accuracy is valid if mains voltage is stable during the measurement and PE terminal is free of interfering voltages.

Trip-out measurement is not available for  $I_{\Delta N}=1000$  mA (RCD types B, B+).

Specified accuracy is valid for complete operating range.

## 10.5 Fault loop impedance and prospective fault current

### 10.5.1 No disconnecting device or FUSE selected

#### Fault loop impedance

Measuring range according to EN 61557 is 0.25  $\Omega$  ÷ 9.99k $\Omega$ .

Measuring range ( $\Omega$ )	Resolution ( $\Omega$ )	Accuracy
0.00 ÷ 9.99	0.01	±(5 % of reading + 5 digits)
10.0 ÷ 99.9	0.1	
100 ÷ 999	1	± 10 % of reading
1.00 k ÷ 9.99 k	10	

#### Prospective fault current (calculated value)

Measuring range (A)	Resolution (A)	Accuracy
0.00 ÷ 9.99	0.01	Consider accuracy of fault loop resistance measurement
10.0 ÷ 99.9	0.1	
100 ÷ 999	1	
1.00 k ÷ 9.99 k	10	
10.0 k ÷ 23.0 k	100	

The accuracy is valid if mains voltage is stabile during the measurement.

Test current (at 230 V)..... 6.5 A (10 ms)

Nominal voltage range..... 93 V ÷ 134 V (45 Hz ÷ 65 Hz)

185 V ÷ 266 V (45 Hz ÷ 65 Hz)

### 10.5.2 RCD selected

#### Fault loop impedance

Measuring range according to EN 61557 is 0.46  $\Omega$  ÷ 9.99 k $\Omega$ .

Measuring range ( $\Omega$ )	Resolution ( $\Omega$ )	Accuracy
0.00 ÷ 9.99	0.01	±(5 % of reading + 10 digits)
10.0 ÷ 99.9	0.1	
100 ÷ 999	1	± 10 % of reading
1.00 k ÷ 9.99 k	10	

Accuracy may be impaired in case of heavy noise on mains voltage.

#### Prospective fault current (calculated value)

Measuring range (A)	Resolution (A)	Accuracy
0.00 ÷ 9.99	0.01	Consider accuracy of fault loop resistance measurement
10.0 ÷ 99.9	0.1	
100 ÷ 999	1	
1.00 k ÷ 9.99 k	10	
10.0 k ÷ 23.0 k	100	

Nominal voltage range..... 93 V ÷ 134 V (45 Hz ÷ 65 Hz)

185 V ÷ 266 V (45 Hz ÷ 65 Hz)

No trip out of RCD.

## 10.6 Line impedance and prospective short-circuit current / Voltage drop

### Line impedance

Measuring range according to EN 61557 is 0.25  $\Omega$  ÷ 9.99k $\Omega$ .

Measuring range ( $\Omega$ )	Resolution ( $\Omega$ )	Accuracy
0.00 ÷ 9.99	0.01	±(5 % of reading + 5 digits)
10.0 ÷ 99.9	0.1	
100 ÷ 999	1	± 10 % of reading
1.00 k ÷ 9.99 k	10	

### Prospective short-circuit current (calculated value)

Measuring range (A)	Resolution (A)	Accuracy
0.00 ÷ 0.99	0.01	Consider accuracy of line resistance measurement
1.0 ÷ 99.9	0.1	
100 ÷ 999	1	
1.00 k ÷ 99.99 k	10	
100 k ÷ 199 k	1000	

Test current (at 230 V)..... 6.5 A (10 ms)

Nominal voltage range..... 93 V ÷ 134 V (45 Hz ÷ 65 Hz)

185 V ÷ 266 V (45 Hz ÷ 65 Hz)

321 V ÷ 485 V (45 Hz ÷ 65 Hz)

### Voltage drop (calculated value)

Measuring range (%)	Resolution (%)	Accuracy
0.0 ÷ 99.9	0.1	Consider accuracy of line impedance measurement(s)*

Z<sub>REF</sub> measuring range..... 0.00  $\Omega$  ÷ 20.0  $\Omega$

\*See chapter 5.7.2 *Voltage drop* for more information about calculation of voltage drop result

## 10.7 PE conductor resistance

### 10.7.1 No RCD selected

#### PE conductor resistance

Measuring range ( $\Omega$ )	Resolution ( $\Omega$ )	Accuracy
0.00 ÷ 19.99	0.01	±(5 % of reading + 5 digits)
20.0 ÷ 99.9	0.1	
100.0 ÷ 199.9	0.1	± 10 % of reading
200 ÷ 1999	1	

### 10.7.2 RCD selected

#### PE conductor resistance

Measuring range ( $\Omega$ )	Resolution ( $\Omega$ )	Accuracy
0.00 ÷ 19.99	0.01	±(5 % of reading + 10 digits)
20.0 ÷ 99.9	0.1	
100.0 ÷ 199.9	0.1	± 10 % of reading
200 ÷ 1999	1	

Accuracy may be impaired in case of heavy noise on mains voltage.

Nominal voltage range..... 93 V ÷ 134 V (45 Hz ÷ 65 Hz)  
185 V ÷ 266 V (45 Hz ÷ 65 Hz)

No trip out of RCD.

## 10.8 Resistance to earth

### 10.8.1 Standard earthing resistance measurement – 3-wire measurement

Measuring range according to EN61557-5 is  $2.00 \Omega \div 1999 \Omega$ .

Measuring range ( $\Omega$ )	Resolution ( $\Omega$ )	Accuracy
0.00 ÷ 19.99	0.01	±(5% of reading + 5 digits)
20.0 ÷ 199.9	0.1	
200 ÷ 9999	1	

Max. auxiliary earth electrode resistance  $R_C$ ..... $100 \times R_E$  or 50 k $\Omega$  (whichever is lower)

Max. probe resistance  $R_P$  ..... $100 \times R_E$  or 50 k $\Omega$  (whichever is lower)

Additional probe resistance error at  $R_{Cmax}$  or  $R_{Pmax}$ . ±(10 % of reading + 10 digits)

Additional error at 3 V voltage noise (50 Hz).....±(5 % of reading + 10 digits)

Open circuit voltage .....<30 VAC

Short circuit current .....< 30 mA

Test voltage frequency .....125 Hz

Test voltage shape .....sine wave

Noise voltage indication threshold .....1 V (< 50  $\Omega$ , worst case)

Automatic measurement of auxiliary electrode resistance and probe resistance.

Automatic measurement of voltage noise.

### 10.8.2 Contactless earthing resistance measurement using two current clamps

Measuring range ( $\Omega$ )	Resolution ( $\Omega$ )	Accuracy <sup>*)</sup>
0.00 ÷ 19.99	0.01	±(10% of reading + 10 digits)
20.0 ÷ 30.0	0.1	±(20% of reading)
30.1 ÷ 39.9	0.1	±(30% of reading)

<sup>\*)</sup> Distance between test clamps > 30 cm.

Additional error at 3 V voltage noise (50 Hz).....±10 % of reading

Test voltage frequency .....125 Hz

Noise current indication .....yes

Low clamp current indication .....yes

Additional clamp error has to be considered.

### 10.8.3 Specific earth resistance measurements

Measuring range ( $\Omega\text{m}$ )	Resolution ( $\Omega\text{m}$ )	Accuracy
0.0 ÷ 99.9	0.1	See accuracy note
100 ÷ 999	1	
1.00 k ÷ 9.99 k	0.01 k	
10.0 k ÷ 99.9 k	0.1 k	
100 k ÷ 9999 k	1 k	

Measuring range ( $\Omega\text{ft}$ )	Resolution ( $\Omega\text{ft}$ )	Accuracy
0.0 ÷ 99.9	0.1	See accuracy note
100 ÷ 999	1	
1.00 k ÷ 9.99 k	0.01 k	
10.0 k ÷ 99.9 k	0.1 k	
100 k ÷ 9999 k	1 k	

Principle:

$$\rho = 2 \cdot \pi \cdot \text{distance} \cdot R_e,$$

with  $R_e$  as measured resistance in 4-wire method.

**Accuracy note:**

- Accuracy of the specific earth resistance result depends on measured resistance  $R_e$  and is as follows:

Measuring range ( $\Omega$ )	Accuracy
1.00 ÷ 1999	±5 % of measured
2000 ÷ 19.99k	±10 % of measured
>20k	±20 % of measured

Additional error:

See *Earth resistance three-wire method*.

## 10.9 Voltage, frequency, and phase rotation

### 10.9.1 Phase rotation

Nominal system voltage range..... 100 V<sub>AC</sub> ÷ 550 V<sub>AC</sub>  
 Nominal frequency range..... 14 Hz ÷ 500 Hz  
 Result displayed ..... 1.2.3 or 3.2.1

### 10.9.2 Voltage

Measuring range (V)	Resolution (V)	Accuracy
0 ÷ 550	1	±(2 % of reading + 2 digits)

Result type ..... True r.m.s. (TRMS)  
 Nominal frequency range..... 0 Hz, 14 Hz ÷ 500 Hz

### 10.9.3 Frequency

Measuring range (Hz)	Resolution (Hz)	Accuracy
0.00 ÷ 9.99	0.01	±(0.2 % of reading + 1 digit)
10.0 ÷ 499.9	0.1	

Nominal voltage range..... 10 V ÷ 550 V

### 10.9.4 Online terminal voltage monitor

Measuring range (V)	Resolution (V)	Accuracy
10 ÷ 550	1	±(2 % of reading + 2 digits)



## 10.10 TRMS Clamp current

Instrument

Maximum voltage on C1 measuring input..... 3 V

Nominal frequency..... 0 Hz, 40 Hz ÷ 500 Hz

AC current clamp A1018

Range = 20 A

Measuring range (A)	Resolution (A)	Accuracy*
0.0 m ÷ 99.9 m	0.1 m	±(5 % of reading + 5 digits)
100 m ÷ 999 m	1 m	±(3 % of reading + 3 digits)
1.00 ÷ 19.99	0.01	±(3 % of reading)

AC current clamp A1019

Range = 20 A

Measuring range (A)	Resolution (A)	Accuracy*
0.0 m ÷ 99.9 m	0.1 m	indicative
100 m ÷ 999 m	1 m	±(5 % of reading)
1.00 ÷ 19.99	0.01	±(3 % of reading)

AC / DC current clamp A1391

Range = 40 A

Measuring range (A)	Resolution (A)	Accuracy*
0.00 ÷ 1.99	0.01	±(3 % of reading + 3 digits)
2.00 ÷ 19.99	0.01	±(3 % of reading)
20.0 ÷ 39.9	0.1	±(3 % of reading)

Range = 300 A

Measuring range (A)	Resolution (A)	Accuracy*
0.00 ÷ 19.99	0.01	indicative
20.0 ÷ 39.9	0.1	
40.0 ÷ 299.9	0.1	±(3 % of reading + 5 digits)

\* Accuracy at operating conditions for instrument and current clamp is given.

## 10.11 Power tests

Measurement characteristics

Function symbols	Class according to IEC 61557-12	Measuring range
P	2.5	5 % ÷ 100 % $I_{Nom}^{(1)}$
Q	2.5	5 % ÷ 100 % $I_{Nom}^{(1)}$
S	2.5	5 % ÷ 100 % $I_{Nom}^{(1)}$
PF	1	- 1 ÷ 1
f	0.05	40 Hz ÷ 60 Hz
I, $I_{Nom}$	1.5	5 % ÷ 100 % $I_{Nom}$
U	1.5	110 V ÷ 500 V
$U_{h_n}$	2.5	0 % ÷ 20 % $U_{Nom}$
THDu	2.5	0 % ÷ 20 % $U_{Nom}$
$I_{h_n}$	2.5	0 % ÷ 100 % $I_{Nom}$
THDi	2.5	0 % ÷ 100 % $I_{Nom}$

<sup>(1)</sup> –  $I_{Nom}$  depends on set current sensor type and selected current range:

A 1018, A1019 (20 A),

A 1391 (40 A or 300 A)

**Note:**

- Error of external voltage and current transducers is not considered in this specification.

Function	Measuring range
Power (P, S, Q)	0.00 W (VA, Var) ÷ 99.9 kW (kVA, kVar)
Power factor	-1.00 ÷ 1.00
Voltage harmonics	0.1 V ÷ 500 V
Voltage THD	0.1 % ÷ 99.9 %
Current harmonics and Current THD	0.00 A ÷ 199.9 A

**Note:**

- Error of external voltage and current transducers is not considered in this specification.

## 10.12 First fault leakage current – ISFL (MI 3102 BT only)

Measuring range (mA)	Resolution (mA)	Accuracy
0.0 ÷ 19.9	0.1	±(5 % of reading + 3 digits)

Measuring resistance..... approx. 390 Ω  
 Nominal voltage ranges ..... 93 V ≤ U<sub>L1-L2</sub> < 134 V  
 185 V ≤ U<sub>L1-L2</sub> ≤ 266 V

## 10.13 Calibrated resistance for IMD testing (MI 3102 BT only)

### Threshold indicative insulation resistance

Measuring range (kΩ)	Resolution (kΩ)	Notes
5 ÷ 640	5	Indicative values Up to 128 steps

Nominal voltage ranges ..... 93 V ≤ U<sub>L1-L2</sub> ≤ 134 V  
 185 V ≤ U<sub>L1-L2</sub> ≤ 266 V

### First fault leakage current at threshold insulation resistance

Measuring range (mA)	Resolution (mA)	Note
0.0 ÷ 19.9	0.1	calculated value <sup>*)</sup>

<sup>\*)</sup>See chapter 5.14 *Testing of insulation monitoring devices – IMD (MI 3102 BT only)* for more information about calculation of first fault leakage current at threshold insulation resistance.

## 10.14 Illumination

### 10.14.1 Illumination (Luxmeter sensor, type B)

Specified accuracy is valid for complete operating range.

Measuring range (lux)	Resolution (lux)	Accuracy
0.01 ÷ 19.99	0.01	±(5 % of reading + 2 digits)
20.0 ÷ 199.9	0.1	±(5 % of reading)
200 ÷ 1999	1	
2.00 ÷ 19.99 k	10	

Measurement principle .....silicon photodiode with V(λ) filter

Spectral response error .....< 3.8 % according to CIE curve

Cosine error.....< 2.5 % up to an incident angle of ± 85°

Overall accuracy.....matched to DIN 5032 class B standard

### 10.14.2 Illumination (Luxmeter sensor, type C)

Specified accuracy is valid for complete operating range.

Measuring range (lux)	Resolution (lux)	Accuracy
0.01 ÷ 19.99	0.01	±(10 % of reading + 3 digits)
20.0 ÷ 199.9	0.1	±(10 % of reading)
200 ÷ 1999	1	
2.00 ÷ 19.99 k	10	

Measurement principle .....silicon photodiode

Cosine error.....< 2.5 % up to an incident angle of ± 85°

Overall accuracy.....matched to DIN 5032 class C standard

## 10.15 General data

Power supply voltage	9 V <sub>DC</sub> (6×1.5 V battery or accu, size AA)
Operation.....	typical 20 h
Charger socket input voltage .....	12 V ± 10 %
Charger socket input current.....	400 mA max.
Battery charging current .....	250 mA (internally regulated)
Measuring category .....	600 V CAT III
	300 V CAT IV
Protection classification .....	double insulation
Pollution degree.....	2
Protection degree .....	IP 40
Display .....	128x64 dots matrix display with backlight
Dimensions (w × h × d) .....	23 cm × 10.3 cm × 11.5 cm
Weight .....	1.3 kg, without battery cells
Reference conditions	
Reference temperature range.....	10 °C ÷ 30 °C
Reference humidity range.....	40 %RH ÷ 70 %RH
Operation conditions	
Working temperature range .....	0°C ÷ 40 °C
Maximum relative humidity .....	95 %RH (0°C ÷ 40 °C), non-condensing
Storage conditions	
Temperature range.....	-10°C ÷ +70 °C
Maximum relative humidity .....	90 %RH (-10°C ÷ +40 °C)
	80 %RH (40°C ÷ 60 °C)
Communication transfer speed	
RS 232 .....	57600 baud
USB.....	256000 baud
Size of memory.....	up to 1800 measurements

The error in operating conditions could be at most the error for reference conditions (specified in the manual for each function) +1 % of measured value + 1 digit, unless otherwise specified in the manual for particular function.

## Appendix A – Fuse table – IPSC

### Fuse type NV

Rated current (A)	Disconnection time [s]				
	35m	0.1	0.2	0.4	5
	Min. prospective short-circuit current (A)				
2	32.5	22.3	18.7	15.9	9.1
4	65.6	46.4	38.8	31.9	18.7
6	102.8	70	56.5	46.4	26.7
10	165.8	115.3	96.5	80.7	46.4
16	206.9	150.8	126.1	107.4	66.3
20	276.8	204.2	170.8	145.5	86.7
25	361.3	257.5	215.4	180.2	109.3
35	618.1	453.2	374	308.7	169.5
50	919.2	640	545	464.2	266.9
63	1217.2	821.7	663.3	545	319.1
80	1567.2	1133.1	964.9	836.5	447.9
100	2075.3	1429	1195.4	1018	585.4
125	2826.3	2006	1708.3	1454.8	765.1
160	3538.2	2485.1	2042.1	1678.1	947.9
200	4555.5	3488.5	2970.8	2529.9	1354.5
250	6032.4	4399.6	3615.3	2918.2	1590.6
315	7766.8	6066.6	4985.1	4096.4	2272.9
400	10577.7	7929.1	6632.9	5450.5	2766.1
500	13619	10933.5	8825.4	7515.7	3952.7
630	19619.3	14037.4	11534.9	9310.9	4985.1
710	19712.3	17766.9	14341.3	11996.9	6423.2
800	25260.3	20059.8	16192.1	13545.1	7252.1
1000	34402.1	23555.5	19356.3	16192.1	9146.2
1250	45555.1	36152.6	29182.1	24411.6	13070.1

## Fuse type gG

Rated current (A)	Disconnection time [s]				
	35m	0.1	0.2	0.4	5
	Min. prospective short-circuit current (A)				
2	32.5	22.3	18.7	15.9	9.1
4	65.6	46.4	38.8	31.9	18.7
6	102.8	70	56.5	46.4	26.7
10	165.8	115.3	96.5	80.7	46.4
13	193.1	144.8	117.9	100	56.2
16	206.9	150.8	126.1	107.4	66.3
20	276.8	204.2	170.8	145.5	86.7
25	361.3	257.5	215.4	180.2	109.3
32	539.1	361.5	307.9	271.7	159.1
35	618.1	453.2	374	308.7	169.5
40	694.2	464.2	381.4	319.1	190.1
50	919.2	640	545	464.2	266.9
63	1217.2	821.7	663.3	545	319.1
80	1567.2	1133.1	964.9	836.5	447.9
100	2075.3	1429	1195.4	1018	585.4

## Fuse type B

Rated current (A)	Disconnection time [s]				
	35m	0.1	0.2	0.4	5
	Min. prospective short-circuit current (A)				
6	30	30	30	30	30
10	50	50	50	50	50
13	65	65	65	65	65
15	75	75	75	75	75
16	80	80	80	80	80
20	100	100	100	100	100
25	125	125	125	125	125
32	160	160	160	160	160
40	200	200	200	200	200
50	250	250	250	250	250
63	315	315	315	315	315

## Fuse type C

Rated current (A)	Disconnection time [s]				
	35m	0.1	0.2	0.4	5
	Min. prospective short-circuit current (A)				
0.5	5	5	5	5	2.7
1	10	10	10	10	5.4
1.6	16	16	16	16	8.6
2	20	20	20	20	10.8
4	40	40	40	40	21.6
6	60	60	60	60	32.4
10	100	100	100	100	54
13	130	130	130	130	70.2
15	150	150	150	150	83
16	160	160	160	160	86.4
20	200	200	200	200	108
25	250	250	250	250	135
32	320	320	320	320	172.8
40	400	400	400	400	216
50	500	500	500	500	270
63	630	630	630	630	340.2

## Fuse type K

Rated current (A)	Disconnection time [s]				
	35m	0.1	0.2	0.4	
	Min. prospective short-circuit current (A)				
0.5	7.5	7.5	7.5	7.5	
1	15	15	15	15	
1.6	24	24	24	24	
2	30	30	30	30	
4	60	60	60	60	
6	90	90	90	90	
10	150	150	150	150	
13	195	195	195	195	
15	225	225	225	225	
16	240	240	240	240	
20	300	300	300	300	
25	375	375	375	375	
32	480	480	480	480	



## Fuse type D

Rated current (A)	Disconnection time [s]				
	35m	0.1	0.2	0.4	5
	Min. prospective short-circuit current (A)				
0.5	10	10	10	10	2.7
1	20	20	20	20	5.4
1.6	32	32	32	32	8.6
2	40	40	40	40	10.8
4	80	80	80	80	21.6
6	120	120	120	120	32.4
10	200	200	200	200	54
13	260	260	260	260	70.2
15	300	300	300	300	81
16	320	320	320	320	86.4
20	400	400	400	400	108
25	500	500	500	500	135
32	640	640	640	640	172.8

## Appendix B – Accessories for specific measurements

The table below presents recommended standard and optional accessories required for specific measurement. Please see attached list of standard accessories for your set or contact your distributor for further information.

Function	Suitable accessories (Optional with ordering code A....)
Insulation resistance	<input type="checkbox"/> Test lead, 3 x 1.5 m <input type="checkbox"/> Tip commander (A 1401) <input type="checkbox"/> 2.5 kV test lead (2 x 1.5 m)*
R LOW $\Omega$ resistance Continuity	<input type="checkbox"/> Test lead, 3 x 1.5 m <input type="checkbox"/> Tip commander (A 1401) <input type="checkbox"/> Test lead, 4 m (A 1012)
Line impedance Voltage drop Fault loop impedance	<input type="checkbox"/> Test lead, 3 x 1.5 m <input type="checkbox"/> Plug commander (A 1314) <input type="checkbox"/> Mains measuring cable <input type="checkbox"/> Tip commander (A 1401) <input type="checkbox"/> Three-phase adapter with switch (A 1111)
Earth connection resistance	<input type="checkbox"/> Test lead, 3 x 1.5 m <input type="checkbox"/> Plug commander (A 1314) <input type="checkbox"/> Mains measuring cable <input type="checkbox"/> Tip commander (A 1401)
RCD testing	<input type="checkbox"/> Test lead, 3 x 1.5 m <input type="checkbox"/> Plug commander (A 1314) <input type="checkbox"/> Mains measuring cable <input type="checkbox"/> Three-phase adapter with switch (A 1111)
Earth resistance - RE	<input type="checkbox"/> Test lead, 3 x 1.5 m <input type="checkbox"/> Earth test set, 3-wire, 20 m (S 2026) <input type="checkbox"/> Earth test set, 3-wire, 50 m (S 2027)
Earth resistance - two clamps	<input type="checkbox"/> Test lead, 3 x 1.5 m <input type="checkbox"/> AC current clamp (A 1018) <input type="checkbox"/> AC current clamp (A 1019) <input type="checkbox"/> AC/ DC current clamp (A 1391)
Specific earth resistance - $\rho$	<input type="checkbox"/> $\rho$ Adapter (A 1199)
Phase sequence	<input type="checkbox"/> Test lead, 3 x 1.5 m <input type="checkbox"/> Three-phase adapter (A 1110) <input type="checkbox"/> Three-phase adapter with switch (A 1111)
Voltage, frequency	<input type="checkbox"/> Test lead, 3 x 1.5 m <input type="checkbox"/> Plug commander (A 1314) <input type="checkbox"/> Mains measuring cable <input type="checkbox"/> Tip commander (A 1401)
Power Harmonics	<input type="checkbox"/> Test lead, 3 x 1.5 m <input type="checkbox"/> Mains measuring cable <input type="checkbox"/> Plug commander (A 1314) <input type="checkbox"/> Tip commander (A 1401) <input type="checkbox"/> AC current clamp (A 1018) <input type="checkbox"/> AC current clamp (A 1019) <input type="checkbox"/> AC/ DC current clamp (A 1391)
Current	<input type="checkbox"/> AC current clamp (A 1018) <input type="checkbox"/> AC current clamp (A 1019) <input type="checkbox"/> AC/DC current clamp (A 1391)
Sensor	<input type="checkbox"/> Luxmeter sensor, type B (A 1172)

	<input type="checkbox"/> Luxmeter sensor, type C (A 1173)
Diagnostic test*	<input type="checkbox"/> Test lead, 3 x 1.5 m <input type="checkbox"/> Tip commander (A 1401) <input type="checkbox"/> 2.5 kV test lead (2 x 1.5 m)*
ISFL**	<input type="checkbox"/> Test lead, 3 x 1.5 m <input type="checkbox"/> Plug commander (A 1314) <input type="checkbox"/> Mains measuring cable <input type="checkbox"/> Tip commander (A 1401)
IMD checker**	<input type="checkbox"/> Test lead, 3 x 1.5 m <input type="checkbox"/> Plug commander (A 1314) <input type="checkbox"/> Mains measuring cable <input type="checkbox"/> Tip commander (A 1401)
Auto sequences	<input type="checkbox"/> Test lead, 3 x 1.5 m <input type="checkbox"/> Plug commander (A 1314) <input type="checkbox"/> Mains measuring cable <input type="checkbox"/> Tip commander (A 1401)

\* MI 3102H BT only.

\*\* MI 3102 BT only.

## Appendix C – Country notes

This appendix C contains collection of minor modifications related to particular country requirements. Some of the modifications mean modified listed function characteristics related to main chapters and others are additional functions. Some minor modifications are related also to different requirements of the same market that are covered by various suppliers.

### C.1 List of country modifications

The following table contains current list of applied modifications.

Country	Related chapters	Modification type	Note
AT	5.5, C.2.1	Appended	Special G type RCD









### C.2 AT modification – G type RCD

Modified is the following related to the mentioned in the chapter 5.5:

- Added G type RCD,
- Time limits are the same as for general type RCD,
- Contact voltage is calculated the same as for general type RCD.



Modifications of the chapter 5.5:

Test parameters for RCD test and measurement

TEST	RCD sub-function test [ $U_c$ , RCDt, RCD I, AUTO]
$I_{\Delta N}$	<b>Rated RCD residual current sensitivity <math>I_{\Delta N}</math></b> [10 mA, 30 mA, 100 mA, 300 mA, 500 mA, 1000 mA].
type	<b>RCD type</b> [AC, A, F, B*, B+*]. <b>starting polarity</b> [  ,  ,  ,  ,  *]. <b>Property selection</b> [selective  , general non-delayed  , delayed  , PRCD, PRCD-K, PRCD-S, MI RCD*, EV RCD*].
MUL	<b>Multiplication factor for test current</b> [ $\frac{1}{2}$ , 1, 2, 5, $\times I_{\Delta N}$ ].
Ulim	<b>Conventional touch voltage limit</b> [25 V, 50 V].

\* Model MI 3102 BT only.

**Note:**

- Selective (time delayed) RCDs and RCDs with (G) - time delayed characteristic demonstrates delayed response characteristics. They contain residual current integrating mechanism for generation of delayed trip out. However, contact voltage pre-test in the measuring procedure also influences the RCD and it takes a period to recover into idle state. Time delay of 30 s is inserted before performing trip-out test to recover  type RCD after pre-tests and time delay of 5 s is inserted for the same purpose for  type RCD.

### C.3 Modification of the chapter 5.5.1.

RCD type		Contact voltage $U_c$ proportional to	Rated $I_{\Delta N}$
AC EV, MI (a.c. part)	<input type="checkbox"/> , <input type="checkbox"/>	$1.05 \times I_{\Delta N}$	any
AC	<input type="checkbox"/>	$2 \times 1.05 \times I_{\Delta N}$	
A, F	<input type="checkbox"/> , <input type="checkbox"/>	$1.4 \times 1.05 \times I_{\Delta N}$	$\geq 30$ mA
A, F	<input type="checkbox"/>	$2 \times 1.4 \times 1.05 \times I_{\Delta N}$	
A, F	<input type="checkbox"/> , <input type="checkbox"/>	$2 \times 1.05 \times I_{\Delta N}$	< 30 mA
A, F	<input type="checkbox"/>	$2 \times 2 \times 1.05 \times I_{\Delta N}$	
B, B+	<input type="checkbox"/>	$2 \times 1.05 \times I_{\Delta N}$	any
B, B+	<input type="checkbox"/>	$2 \times 2 \times 1.05 \times I_{\Delta N}$	

**Table C.1:** Relationship between  $U_c$  and  $I_{\Delta N}$

Technical specifications remain the same.

## Appendix D – Commanders (A 1314, A 1401)

### D.1 ⚠ Warnings related to safety

#### Measuring category of commanders

Plug commander A 1314 ..... 300 V CAT II

Tip commander A 1401

(cap off, 18 mm tip) ..... 1000 V CAT II / 600 V CAT II / 300 V CAT II

(cap on, 4 mm tip) ..... 1000 V CAT II / 600 V CAT III / 300 V CAT IV

- ❑ Measuring category of commanders can be lower than protection category of the instrument.
- ❑ If dangerous voltage is detected on the tested PE terminal, immediately stop all measurements, find and remove the fault!
- ❑ When replacing battery cells or before opening the battery compartment cover, disconnect the measuring accessory from the instrument and installation.
- ❑ Service, repairs or adjustment of instruments and accessories is only allowed to be carried out by competent authorized personnel!

### D.2 Battery

The commander uses two AAA size alkaline or rechargeable Ni-MH battery cells.

Nominal operating time is at least 40 h and is declared for cells with nominal capacity of 850 mAh.

#### Notes:

- ❑ If the commander is not used for a long period of time, remove all batteries from the battery compartment.
- ❑ Alkaline or rechargeable Ni-MH batteries (size AA) can be used. Metrel recommends only using rechargeable batteries with a capacity of 800 mAh or above.
- ❑ Ensure that the battery cells are inserted correctly otherwise the commander will not operate and the batteries could be discharged.

### D.3 Description of commanders

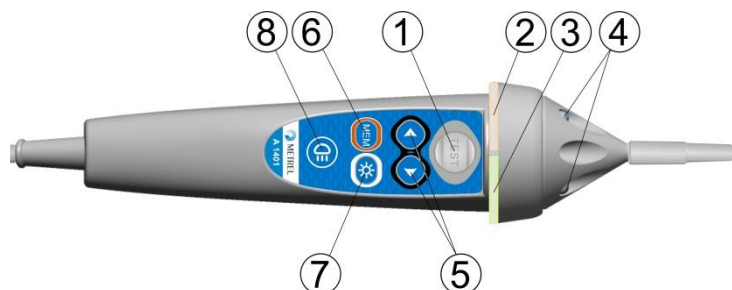

Figure D.1: Front side tip commander (A 1401)

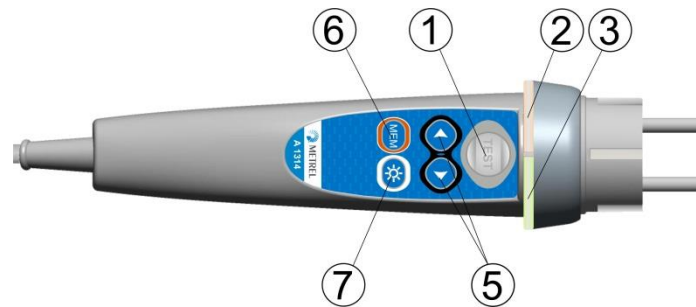

Figure D.2: Front side plug commander (A 1314)

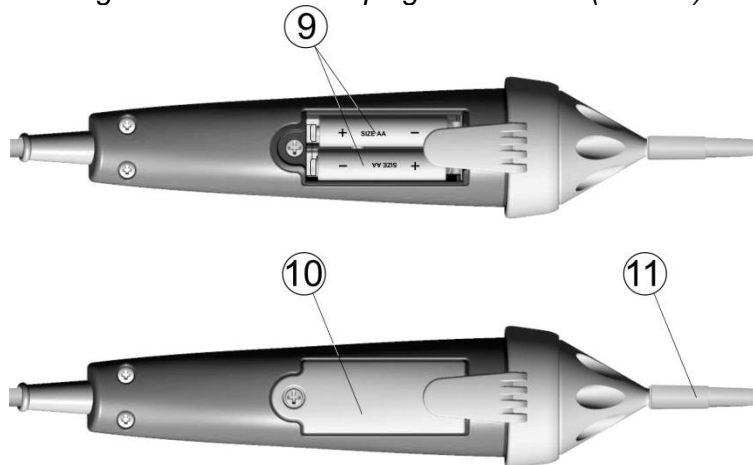

Figure D.3: Back side

Legend:

1	TEST	TEST	Starts measurements. Acts also as the PE touching electrode.
2	LED	Left status RGB LED	
3	LED	Right status RGB LED	
4	LEDs	Lamp LEDs (Tip commander)	
5	Function selector	Selects test function.	
6	MEM	Store / recall / clear tests in memory of instrument.	
7	BL	Switches On / Off backlight on instrument	
8	Lamp key	Switches On / Off lamp (Tip commander)	
9	Battery cells	Size AAA, alkaline / rechargeable NiMH	
10	Battery cover	Battery compartment cover	
11	Cap	Removable CAT IV cap (Tip commander)	

## D.4 Operation of commanders

Both LED yellow	Warning! Dangerous voltage on the commander's PE terminal!
Right LED red	Fail indication
Right LED green	Pass indication
Left LED blinks blue	Commander is monitoring the input voltage
Left LED orange	Voltage between any test terminals is higher than 50 V
Both LEDs blink red	Low battery
Both LEDs red and switch off	Battery voltage too low for operation of commander

**PE terminal test procedure**

- ❑ **Connect** commander to the instrument.
- ❑ **Connect** commander to the item to be tested (see *Figure D.4*).
- ❑ Touch PE test probe (the **TEST** key) on commander for at least one second.
- ❑ If PE terminal is connected to phase voltage both LEDs will light yellow, the warning message on the instrument is displayed, instrument's buzzer is activated, and further measurements are disabled in Zloop and RCD functions.

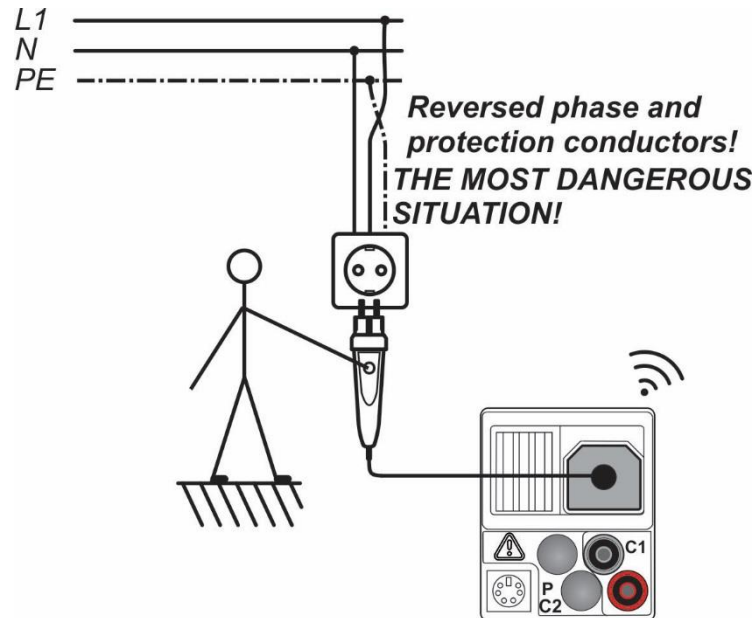

Figure D.4: Reversed L and PE conductors (application of plug commander)